

# DigiTMR S2™

## DIGITAL CIRCUIT BREAKER ANALYZER

### USER'S MANUAL



**Vanguard Instruments Company, Inc.**

1520 S. Hellman Ave.

Ontario, California 91761, USA

TEL: (909) 923-9390  
FAX: (909) 923-9391

July 2012  
Revision 1

## SAFETY SUMMARY

### FOLLOW EXACT OPERATING PROCEDURES

Any deviation from the procedures described in this User's Manual may create one or more safety hazards, may damage the DigiTMR S2, or cause errors in the test results. Vanguard Instruments Company, Inc. assumes no liability for unsafe or improper use of the DigiTMR S2.

All safety precautions provided in this manual must be observed during all phases of testing including test preparation, test lead connection, actual testing, and test lead disconnection.

### SAFETY WARNING AND CAUTIONS

The DigiTMR S2 shall be used only by **trained operators**. When using the DigiTMR S2 in Time-versus-Travel mode, all circuit breakers under test shall be **off-line** and **fully isolated**.

### DO NOT MODIFY TEST EQUIPMENT

To avoid the risk of introducing additional or unknown hazards, do not install substitute parts or perform any unauthorized modification to any DigiTMR S2 test unit. To ensure that all designed safety features are maintained, it is highly recommended that repairs be performed only by Vanguard Instruments Company factory personnel or by an authorized repair service provider. Unauthorized modifications can cause safety hazards and will void the manufacturer's warranty.

### WARNING

Do not remove test leads during a test. Failure to heed this warning can result in damage to the equipment.

## TABLE OF CONTENTS

CONVENTIONS USED IN THIS DOCUMENT .....	1
1.0 INTRODUCTION .....	2
1.1 General Description and Features .....	2
1.2 Operational Modes .....	5
1.2.1. "On-Line" Mode .....	5
1.2.2. Time-versus-Travel Circuit Breaker Analyzer Mode.....	5
1.3 Technical Specifications .....	6
1.4 DigiTMR S2 Controls and Indicators .....	7
2.0 PRE-TEST SETUP .....	8
2.1 Operating Voltages .....	8
2.2 LCD Screen Contrast Control.....	8
2.3 Printer Paper Control .....	8
2.4 Printer Paper .....	8
3.0 OPERATING PROCEDURES .....	10
3.1 Configuring the VCBA S2 Software for use with the DigiTMR S2 .....	10
3.2 Connecting the DigiTMR S2 to a PC via Bluetooth .....	12
3.3 DigiTMR S2 Cable Connections .....	20
3.3.1. Contact Cable Connections .....	20
3.3.2. Initiate Cable Connections .....	21
3.3.3. Analog and Digital Voltage Monitor Connections.....	23
3.3.5. AC Current Sensor Connection.....	26
3.3.6. Transducer Connections.....	27
3.4 General Procedures and Configuration .....	30
3.4.1. Setting the Interface Language .....	31
3.4.2. Setting the Measurement Units .....	33
3.4.3. Setting the DigiTMR S2's Internal Clock .....	36
3.4.4. Entering Test Record Header Information .....	38
3.4.5. Setting the Frequency .....	41
3.4.6. Setting the Default Printing Mode .....	43
3.5 Timing Breakers in On-line Mode .....	45
3.6 Timing Breakers in Time-Travel Mode.....	45
3.7 Performing Timing Tests .....	46
3.7.1. Timing an OPEN Operation With No Insertion Resistors .....	46
3.7.2. Timing an OPEN Operation WITH Insertion Resistors.....	50
3.7.3. Timing a CLOSE-OPEN Operation Using Contact Channel #1.....	53
3.7.4. Timing an OPEN-CLOSE-OPEN Operation.....	56
3.8 Performing Diagnostic Tests .....	59
3.8.1. Performing a Slow-Close Test.....	59
3.8.2. Performing a Transducer Self-Test.....	62
3.8.3. Checking Cable Hookups .....	63
3.9 Printing Test Results .....	65

**TABLE OF CONTENTS (continued)**

3.9.1. Printing the Tabulated Test Results ..... 65

3.9.2. Printing the Graphic Test Results ..... 69

3.10 Working with Timing Shots ..... 75

3.10.1. Saving Timing Shots ..... 75

3.10.2. Printing a Timing Shot Directory ..... 78

3.10.3. Restoring a Test Shot ..... 81

3.10.4. Erasing Timing Shots ..... 84

3.10.5. Copying Test Shots to a USB Flash Drive ..... 89

3.11 Working with Breaker Test Plans ..... 91

3.11.1. Recalling a Breaker Test Plan ..... 92

3.11.2. Printing a Breaker Test Plan ..... 94

3.11.3. Printing the Breaker Test Plan Directory ..... 96

3.12 Setting Up Analysis Points ..... 98

3.12.1. Setting Up the OPEN Analysis Points ..... 98

3.12.2. Setting Up the CLOSE Analysis Points ..... 102

4.0 GLOSSARY OF TERMS ..... 104

5.0 DIGITMR S2 TROUBLE SHOOTING GUIDE ..... 105

**LIST OF TABLES**

Table 1. DigiTMR S2 Technical Specifications ..... 6

Table 2. Descriptions of Tabulated Test Results Elements ..... 68

**LIST OF FIGURES**

Figure 1. DigiTMR S2 Controls and Indicators ..... 7

Figure 2. Contact Cable Connections ..... 20

Figure 3. DC Trip and DC Close Initiate Circuit Cable Connections ..... 21

Figure 4. DC Trip and AC Close Initiate Circuit Cable Connections ..... 22

Figure 5. Analog and Digital Voltage Monitoring Cable Connections ..... 23

Figure 6. External Trigger Cable Connection for an Open Connection ..... 24

Figure 7. External Trigger on a Close Operation Less 52Y Delay Time ..... 25

Figure 8. Typical CT Connection ..... 26

Figure 9. Typical Transducer Connection ..... 27

Figure 10. Typical Resistor Type Transducer Connection ..... 28

Figure 11. Vanguard Resistor Transducer Adapter Connected to an ABB AHMB Transducer ..... 28

Figure 12. Vanguard Doble Transducer Adapter Connected to a Doble Linear Transducer ..... 29

Figure 13. Vanguard Doble Transducer Adapter Connected to a Doble Rotary Transducer ..... 29

Figure 14. DigiTMR S2 General Operating Procedures ..... 30

Figure 15. Typical "Slow-Close" Test Results Printout ..... 61

**LIST OF FIGURES (continued)**

Figure 16. Typical Tabulated Test Results Printout of an OPEN Operation.....	67
Figure 17. Typical Graphic Test Results Printout .....	71
Figure 18. Expansion Graph from 0 to 200 ms .....	72
Figure 19. Graphic Interpretation of an OPEN Timing Shot .....	73
Figure 20. Graphic Interpretation of a CLOSE Timing Shot.....	73
Figure 21. Graphic Interpretations of OPEN-CLOSE and CLOSE-OPEN Timing Shots .....	74
Figure 22. Typical Thumb Drive Shot Directory Printout.....	80
Figure 23. Typical Internal Shot Directory Printout .....	80
Figure 24. Typical Test Plan Printout .....	95
Figure 25. Typical Test Plan Directory Printout .....	97
Figure 26. Linear Transducer on an OCB .....	113
Figure 27. Rotary Transducer on Alstom HE 1014 Circuit Breaker .....	113
Figure 28. Rotary Transducer on ABB HMB Mech.....	114
Figure 29. Westinghouse SFA Transducer Installation .....	114
Figure 30. ABB 72PM Circuit Breaker with Linear Transducer and Special Timing Rod .....	115
Figure 31. Rotary Transducer on Megria Blast Breaker .....	115
Figure 32. Rotary Transducer on Federal Pacific Breaker.....	116
Figure 33. Linear Transducer on Mitsubishi 500-SFMT .....	116
Figure 34. Linear Transducer on Areva DT1-72.5F .....	117

**APPENDIX**

Appendix A. ITE Circuit Breaker Model 14.4K Timing Chart.....	107
Appendix B. DigiTMR S2 Test Plan for ITE Circuit Breaker Model 14.4K .....	108
Appendix C. DigiTMR S2 Timing Chart for ITE Circuit Breaker Model 14.4K .....	109
Appendix D. DigiTMR S2 Timing Chart for ITE Circuit Breaker Model 14.4K.....	110
Appendix E. Timing Chart and Plan for Siemens Type SPS2, 121 Circuit Breaker .....	111
Appendix F. DigiTMR S2 Compatible Transducers and Transducer Adapters .....	112

## CONVENTIONS USED IN THIS DOCUMENT

This document uses the following conventions:

- A key or switch on the DigiTMR S2 is indicated as **[KEY]**.
- Menu options are referenced as (*MENU OPTION*).
- Screen and menu names are referenced as "SCREEN/MENU NAME".
- The terms "test record" and "test shot" are used interchangeably.
- DigiTMR S2 LCD screen output is shown as:

```
1. OPTION 1
2. OPTION 2
3. OPTION 3
4. OPTION 4
5. OPTION 5
```

- When instructions are provided, the menu item that should be selected is shown in bold as shown below (option 5 should be selected):

```
1. OPTION 1
2. OPTION 2
3. OPTION 3
4. OPTION 4
5. OPTION 5
```

- Warning messages are indicated as:



Warning message

**WARNING**

- Important notes are indicated as:



Note details

**NOTE**

## 1.0 INTRODUCTION

### 1.1 General Description and Features

The Vanguard DigiTMR S2 is an inexpensive, easy to use digital circuit breaker analyzer. The DigiTMR S2 can be operated stand-alone or can be computer-controlled. It can fully analyze a circuit-breaker's performance by testing the contact time, stroke, velocity, over-travel, and contact wipe. Contact and motion analysis can be performed for all breaker contact operations (Open, Close, Open – Close, Close – Open, and Open – Close – Open). Timing results are recorded and displayed on the 240 x 128 pixels back-lit LCD screen and can also be printed on the built-in 4.5" wide thermal printer.

#### “On-Line” Timing Mode

In addition to the conventional off-line timing mode, the DigiTMR S2 also offers an optional “on-line” timing mode. In this mode, the DigiTMR S2 captures the breaker's trip or close time, the trip/close coil current “fingerprint,” and the battery supply voltage while the breaker is still in service. The trip/close time is derived from the time of trip, or close coil initiation, to the breaker's bushing current breaker-make as detected by an AC clamp-on current sensing probe.

The “on-line” timing mode can detect a breaker's operating conditions with little or no down time. In this mode, the first trip operation time of the breaker is captured. If a breaker has been in service for a long period of time and sitting in close position, the first trip time of the breaker may be slow possibly due to a sticky mechanism. The “on-line” mode is very useful in such cases because traditional breaker timing may not detect this condition since several operations may have occurred before the first timing test is conducted.

#### Diagnostic Capabilities

The DigiTMR S2 can perform diagnostics on its internal electronics. Diagnostics can be performed to verify contact cable connections and to test the travel transducer's electronics.

#### Open/Close Coil Current Monitoring

A built-in Hall-Effect current sensor records the circuit breaker's operating coil current amplitude and duration. The circuit breakers' operating-coil waveforms (effectively, a performance “fingerprint” or “current profile”) can be used as a diagnostic tool for analyzing a circuit breaker's performance.

#### Internal Test Record and Test Plan Storage

The DigiTMR S2 can store up to 200 test records and 100 circuit breaker test plans in Flash EEPROM. A test plan comprises of all circuit breaker performance specifications (Stroke, Velocity, and Contact Time). When a test plan is used, the DigiTMR S2 compares the test results for the circuit breaker against its performance to generate a “Pass/Fail” report.

Test plans are generated using the included Windows®-based Circuit Breaker Analysis application. Test plans can be transferred to the DigiTMR S2 via the USB or optional Bluetooth interface, or by using an external USB Flash drive. Up to 999 test records and 999 test plans can be stored on an external USB Flash drive.

## Contact Timing Inputs

Dry-contact input channels are used for timing circuit-breaker contacts. Each contact input channel can detect main contact and insertion-resistor contact times in milliseconds and cycles. Three contact timing channels are available on the DigiTMR S2.

## Breaker Stroke and Velocity

One digital transducer input channel is available to measure circuit breaker contact stroke, velocity, over-travel, and bounce-back. With the use of a Vanguard digital travel transducer, no set-up calibration is required before testing. A special feature is also available to “Slow-Close” test a circuit breaker and obtain test results. An optional Resistor Transducer Adapter Device can be used to interface with any resistor transducer.

In Time Travel Mode, the digital transducer measures the breaker stroke, over-travel, bounce back, contact wipe, and contact velocity. Breaker contact velocity calculations are based upon a contact's travel distance over a period of time, which is defined by the manufacturer's specifications. The DigiTMR S2 not only calculates simple distance-over-time velocities, but also supports other formulas. An example is a Siemens SPS2 breaker velocity calculation formula shown below:

$$V = 12.2 \times a/b$$

The formula and analysis points can be stored in a test plan for later use in the field. Please see section 3.11 for further information about test plans.



### NOTE

If a breaker test plan is used during testing, test results are compared with the specifications in the test plan, and a “Pass” or “Fail” indicator is printed on the test report based on the results of this comparison.

## CT Input

One non-contact AC current sensor is used to monitor circuit breaker on-line current for the “on-line” timing mode.

## Voltage Monitoring Input

One analog input channel, designated as (V1), is dedicated to monitoring the substation DC supply or coil voltage (0-255 Volts, DC or peak AC). A second voltage input channel, designated as V2, is dedicated to detecting voltage On/Off status (presence or absence). This input can be used to monitor the status of an A/B switch.

## Circuit Breaker Initiate Feature

A built-in solid-state initiate device is used to operate the circuit breaker from the DigiTMR S2. Operational modes include Open, Close, Open-Close, Close-Open, and Open-Close-Open. Multiple operations such as Open-Close, Close-Open, and Open-Close-Open can be initiated using a programmable delay or by sensing the circuit breaker's contact condition. The circuit breaker coil current amplitudes and waveforms are recorded and can be printed on the thermal printer.



## Computer Interface

One USB interface port and one optional Bluetooth interface is available for computer-control. Vanguard's Windows®- based Circuit Breaker Analyzer application is included with each DigiTMR S2. The software can be used to control the unit, review test records, and create circuit breaker test plans. Test records can be exported to PDF, Excel, and XML format. All future software updates can be downloaded from the Vanguard web site at no additional charge.

## User Interface

The DigiTMR features a back-lit (256 x 128 pixels) graphic LCD screen to display menus and test results. A convenient, rugged, 44-key QWERTY-style keypad is used to control the unit and enter data.

## Built-in Thermal Printer

The DigiTMR S2 features a built-in 4.5" wide thermal printer that can print test results in both tabulated and graphic format.

<http://www.51082245.com>

## 1.2 Operational Modes

### 1.2.1. "On-Line" Mode

In "On-Line" mode, the trip/close time is derived from the time of trip, or close-coil initiation, to the breaker's bushing current-break-or-make as detected by an AC clamp-on current sensing probe. The DigiTMR can time a circuit breaker's OPEN operation by sensing the time when the OPEN coil is energized until the bushing CT current returns to zero. The breaker's CLOSE time is detected when the close coil is energized until the bushing CT current is detected. The "On-Line" mode provides a quick way to diagnose a breaker's performance and can reduce maintenance costs.

### 1.2.2. Time-versus-Travel Circuit Breaker Analyzer Mode

In Time-versus-Travel mode, the DigiTMR S2 applies a test voltage of 35 Vdc to each of the contact channels, thus allowing an analog to digital converter (A/D) to determine a close, open, or an insertion resistor as the state of the contact. The DigiTMR S2 records into memory 20,000 readings (in on second) from the A/D's and the transducer position counters. The contact time, circuit breaker stroke and velocity are then derived from the stored data.

**NOTE**

The DigiTMR S2's travel transducer employs optical encoders to send quadrature signals to the unit's counters. With the use of digital transducers and counters, the need to setup or calibrate the transducers is eliminated.

### 1.3 Technical Specifications

Table 1. DigiTMR S2 Technical Specifications

<b>TYPE</b>	Circuit-breaker analyzer
<b>PHYSICAL SPECIFICATIONS</b>	18.5"W x 14"H x 7"D (47.0 cm x 35.7cm x 17.6 cm); Weight: 20 lbs (9.1 kg)
<b>INPUT POWER</b>	3 Amps, 100 – 240 Vac, 50/60 Hz
<b>DRY-CONTACT INPUTS</b>	3 dry-contact channels; each channel detects main contact and insertion resistor contact
<b>TIMING WINDOWS</b>	1 second, 10 seconds, or 20 seconds
<b>TIMING RESOLUTIONS</b>	±50 micro-seconds @ 1 sec. duration, ±500 micro-seconds @ 10 sec. duration, ±1.0 milliseconds @ 20 sec. duration
<b>TIMING ACCURACY</b>	0.05% of reading ±0.05 milliseconds @ 1 second duration
<b>DRY-CONTACT DETECTION RANGE</b>	Closed: less than 20 ohms; Open: greater than 10,000 Ohms
<b>RESISTOR DETECTION RANGE</b>	50 – 5,000 ohms
<b>TRIGGER INPUT VOLTAGE</b>	Open/Close: 30 – 300 V, DC or peak AC
<b>VOLTAGE SENSING INPUT RANGE</b>	V1: analog input; 0 – 250V, DC or peak AC; Sensitivity: ±1V V2: voltage presence/absence detector input; 30 – 300V, DC or peak AC
<b>BREAKER OPERATIONS</b>	Initiate Open, Close, Open – Close, Close – Open, Open – Close – Open
<b>BREAKER INITIATE CAPACITY</b>	30A, 250 Vac/dc max
<b>INITIATE CURRENT READING RANGE</b>	One, non-contact, Hall-effect sensor, 0 – 20 amp range, dc to 5Khz
<b>DIGITAL TRAVEL TRANSDUCER INPUT</b>	1 digital travel transducer channel; linear range: 0.0 – 60.0 in (±0.005 in) rotary range: 0 – 360 degrees (±0.006 degrees)
<b>CONTACT TRAVEL POINT DIFFERENCE</b>	Measures “slow-close” contact-point distances; results can be printed
<b>CT CURRENT SENSOR</b>	One, non-contact, 0–100A
<b>DISPLAY</b>	Back-lit LCD screen (240 x 128 pixels); viewable in bright sunlight and low light levels
<b>PRINTER</b>	Built-in 4.5-inch wide thermal printer can print both graphic contact travel waveforms and tabulated test results
<b>INTERNAL TEST RECORD STORAGE</b>	Stores up to 200 test records and 100 test plans
<b>COMPUTER INTERFACES</b>	One USB port, optional Bluetooth interface
<b>PC SOFTWARE</b>	Windows®-based Circuit Breaker Analysis software (VCBA S2) included with purchase price. Software updates available at no additional charge
<b>SAFETY ENVIRONMENT</b>	Designed to meet UL/IEC 61010 and CAN/CSA C22.2 No. 1010.1-92 standards Operating: -10°C to 50° C (15°F to +122° F); Storage: -30° C to 70° C (-22°F to +158° F)
<b>HUMIDITY</b>	90% RH @ 40°C (104°F) non-condensing
<b>ALTITUDE</b>	2,000 m (6,562 ft) to full safety specifications
<b>CABLES</b>	Furnished with full set of test leads (including 20-foot contact leads and 30-foot contact lead extensions)
<b>OPTIONS</b>	transportation case (available for the DIGITMR S2 and travel transducers)
<b>WARRANTY</b>	One year on parts and labor



**NOTE**

The above specifications are valid at nominal operating voltage and at a temperature of 25°C (77°F). Specifications may change without prior notice.

### 1.4 DigiTMR S2 Controls and Indicators

The DigiTMR S2's controls and indicators are shown in Figure 1 below. The purpose of the controls and indicators may seem obvious, but users should become familiar with them before using the DigiTMR S2. Accidental misuse of the controls will usually cause no serious harm. Users should also be familiar with the safety summary found on the front page of this User's Manual.

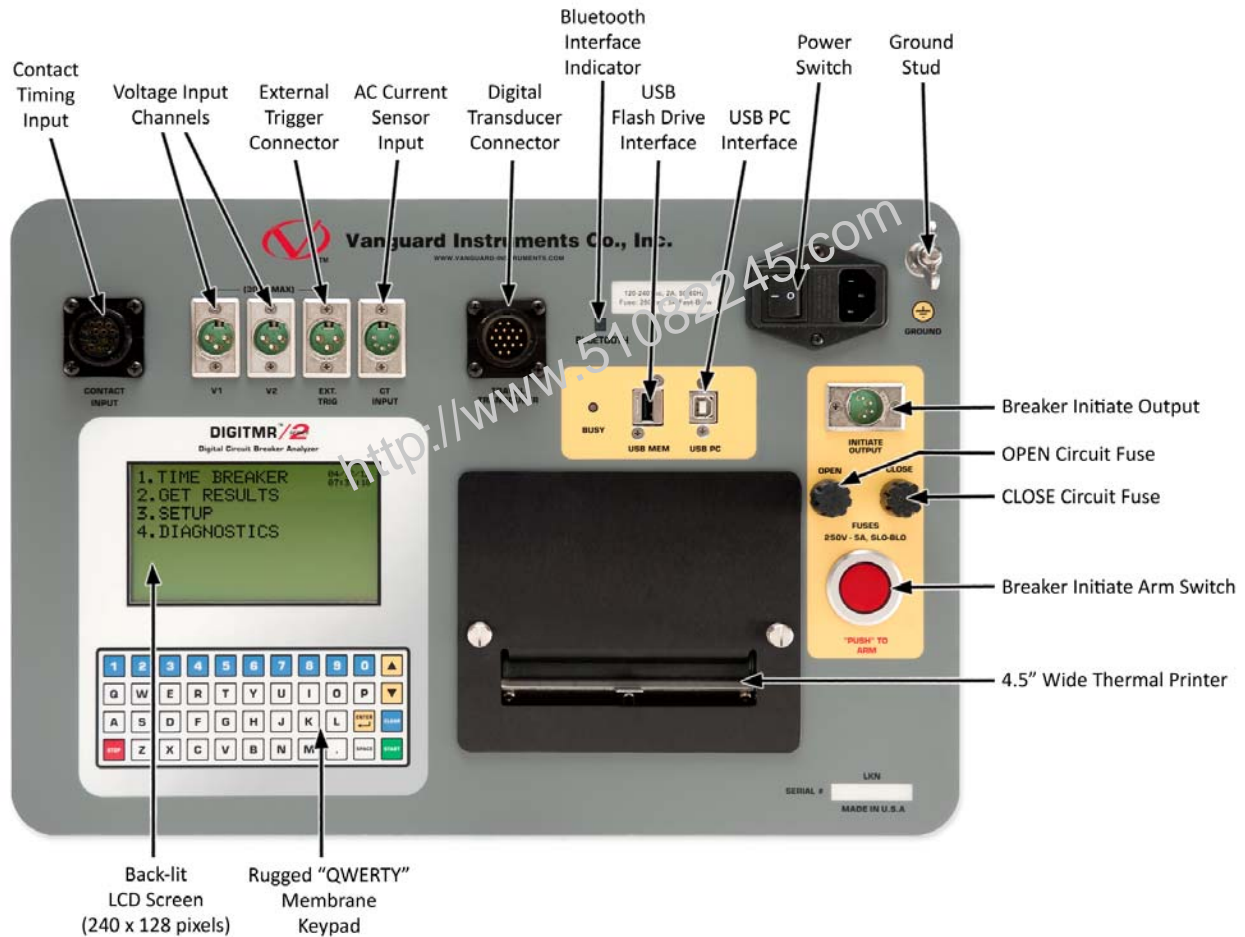

Figure 1. DigiTMR S2 Controls and Indicators

## 2.0 PRE-TEST SETUP

### 2.1 Operating Voltages

The DigiTMR S2 operates on voltages between 100-240 Vac, 50/60 Hz.

### 2.2 LCD Screen Contrast Control

To increase the LCD screen contrast, press and hold the **[^]** key for two seconds.

To decrease the LCD screen contrast, press and hold the **[v]** key for two seconds.

### 2.3 Printer Paper Control

To advance the DigiTMR S2's printer paper, press and release the **[^]** key.

To retract the DigiTMR S2's printer paper, press and release the **[v]** key.

### 2.4 Printer Paper

The DigiTMR S2's built-in thermal printer uses 4.5-inch wide thermal paper for printing test results. To maintain the highest print quality and to avoid paper jams, the use of thermal paper supplied by Vanguard Instruments Company is highly recommended. Additional paper can be ordered from the following sources:

#### **Vanguard Instruments Co, Inc.**

1520 S. Hellman Avenue

Ontario, CA 91761

Tel: 909-923-9390

Fax: 909-923-9391

Part Number: VIC TP-4 paper

#### **BG Instrument Co.**

13607 E. Trent Avenue

Spokane, WA 99216

Tel: 509-893-9881

Fax: 509-893-9803

Part Number: VIC TP-4 paper

## 2.5 Replacing the Thermal Printer Paper

The roll of thermal paper is housed inside a dispenser underneath the printer cover. To replace the paper, follow the steps below:

- Unscrew the two large printer cover screws and remove the printer cover.
- Remove the leftover thermal paper roll from the paper holder.
- Unroll the new thermal paper roll.
- Feed the thermal paper into the slot between the paper pocket and the rubber roller. The printer will automatically pull the paper under the thermal head.
- Place the paper roll into the paper holder.
- Lift the thermal head and align the thermal paper if necessary.
- Re-install the printer cover.



### NOTE

Thermal paper has a chemical coating on one side of the paper. This side should be facing the thermal print head. Incorrect paper loading may result in blank output on the thermal paper.

The thermal paper will show a red stripe to indicate that the roll is about to run out of paper.

## 3.0 OPERATING PROCEDURES

### 3.1 Configuring the VCBA S2 Software for use with the DigiTMR S2

The DigiTMR S2 can be used with a PC (computer control mode) using the Vanguard Circuit Breaker Analyzer Series 2 (VCBA S2) software. From the PC, the user can time circuit breakers, retrieve test records, and create and transfer test plans to the DigiTMR S2. Follow the steps below to properly connect the DigiTMR S2 and configure the VCBA S2 application to recognize the unit.

- a. Install the VCBA S2 software (please see the VCBA S2 software user's manual for details)
- b. Connect the DigiTMR S2 to the PC by connecting a USB cable from an open USB port on the PC to the unit's "USB PC" port.
- c. Turn on the power on the DigiTMR S2.
- d. If this is the first time you are connecting the unit to the PC, Windows will recognize it as a new device and automatically install necessary drivers. If using Windows XP, you may be prompted to install drivers. Select the automatic installation option and Windows will locate the generic drivers necessary.
- e. Please note that although the unit is connected via USB, it uses an internal serial interface to communicate with the PC. As such, it will appear in the windows Device Manager as a USB Serial Port. Open the Device Manager from the Windows Control Panel and note the COM port number. For example, in the installation shown below, the DigiTMR S2 is shown as COM10 (USB Serial Port).

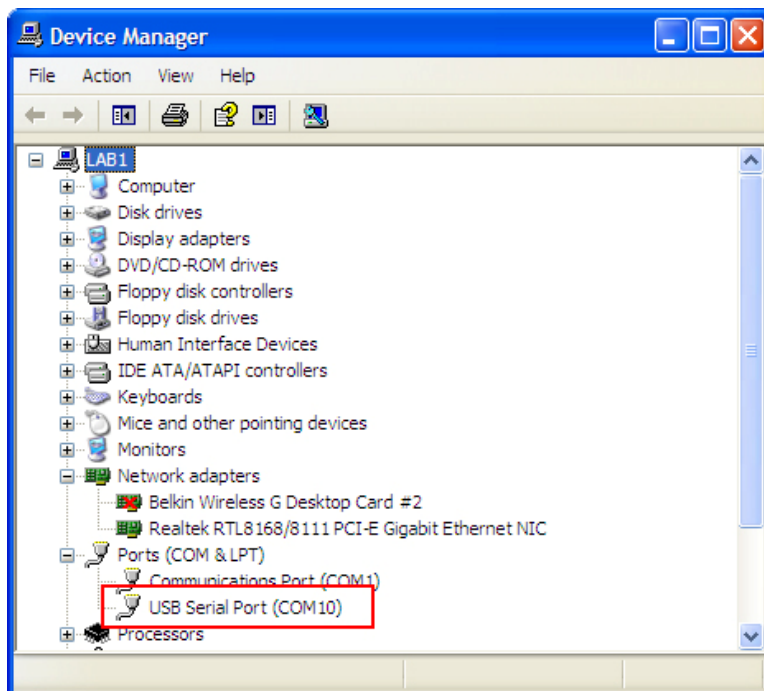

- f. Launch the VCBA S2 application. From the “Sys-Config” menu, select “System Setup...”. The following window will be displayed:

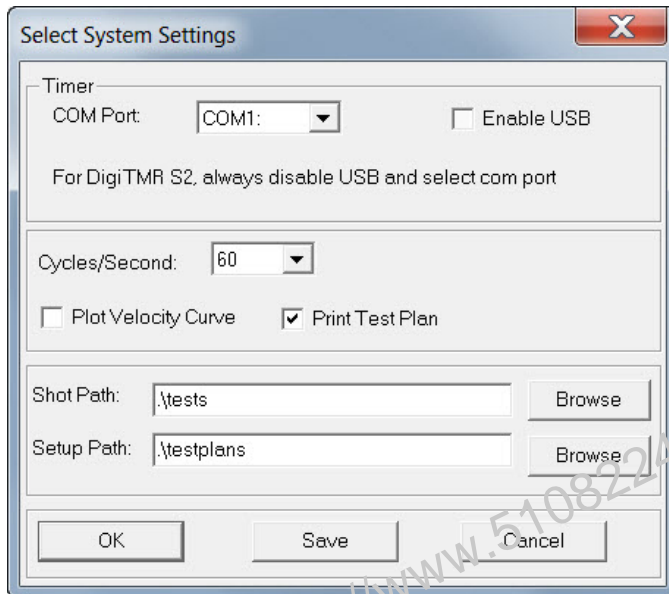

Make sure that the “Enable USB” option is UN-checked. Then, from the “Port” drop-down menu, select the COM port that corresponds to the port that the DigiTMR S2 is connected to. Then click the OK button. The VCBA S2 software will now recognize the DigiTMR S2.



### 3.2 Connecting the DigiTMR S2 to a PC via Bluetooth

The DigiTMR S2 can also be connected wirelessly to a PC using Bluetooth. To connect the unit via Bluetooth, it must first be paired with the PC. Follow the steps below to pair the DigiTMR S2 to a PC via Bluetooth:

#### For Windows XP:

- a. Make sure the DigiTMR S2 is turned on. Then double click on the Bluetooth system tray icon (on the bottom right corner of your computer screen):



- b. The “My Bluetooth Places” window will be displayed:

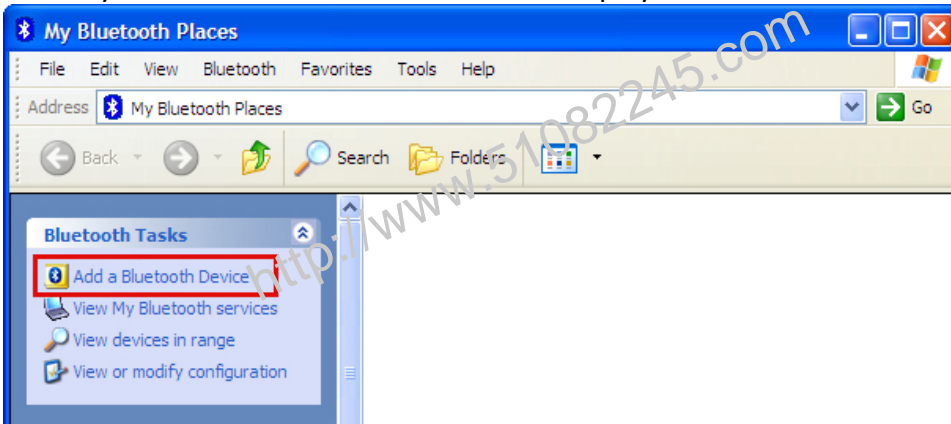

Click on “Add a Bluetooth Device” on the left window pane.

- c. The Bluetooth Setup Wizard window will be displayed. Click on the “Next” button. The PC will scan for nearby devices and list all available Bluetooth devices:

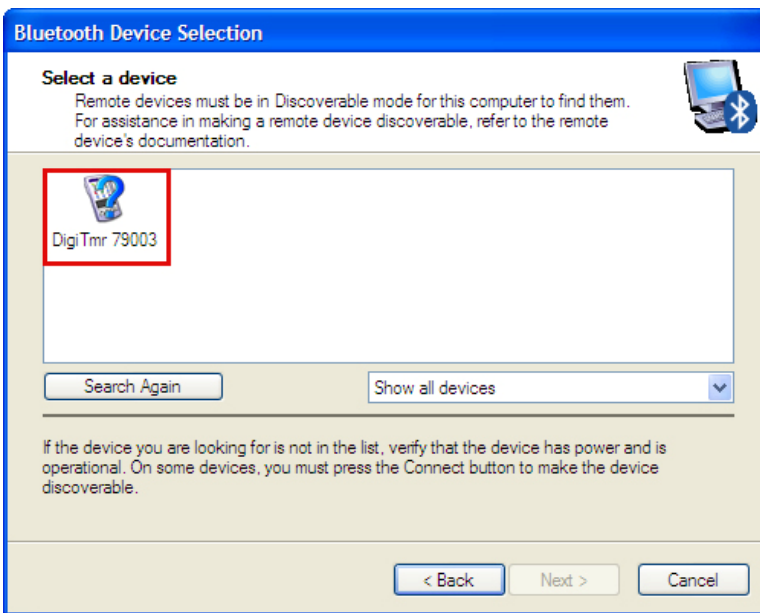

The DigiTMR S2 will be listed as “DigiTmr S/N” where S/N is the device’s serial number. Click on the icon for the DigiTMR and then click on the “Next” button.

- d. The following window will be displayed asking for a secret key to connect to the DigiTMR S2:

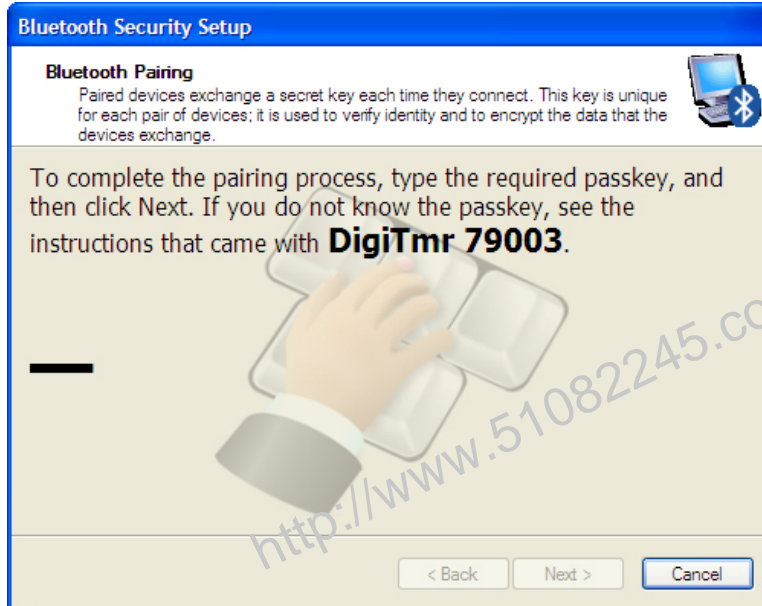

Type the word “default” (without the quotes and in all lower-case) and then click on the “Next” button.

- e. The following window will be displayed with the option to connect to the DigiTMR S2 as a serial port:

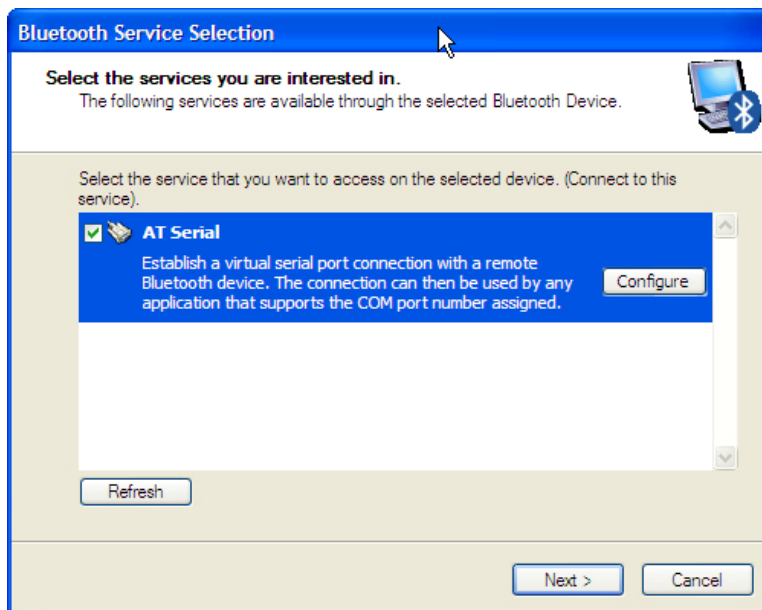

Make sure to check the box next to “AT Serial” and then click on the “Next” button.

- f. The following confirmation screen will be displayed:



Click on the “Finish” button.

- g. The DigiTMR S2 will now be displayed in the “My Bluetooth Places” window:

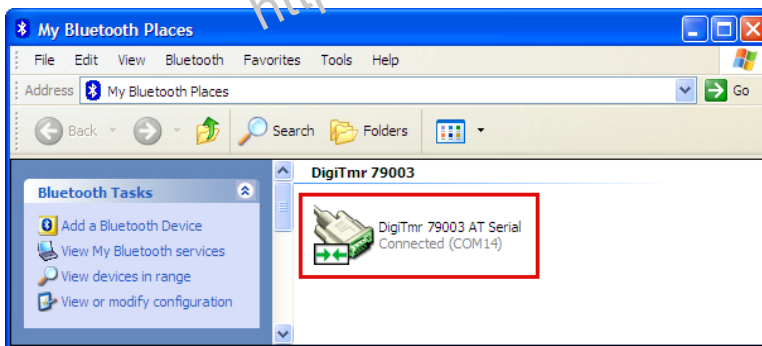

Note the port number listed under the device name. In the above case, the port number is COM14. Follow the directions in section **Error! Reference source not found.** to configure the VCBA S2 software to connect to the DigiTMR S2 using this COM port.

**For Windows 7:**

- a. Make sure the DigiTMR S2 is turned on. Then double click on the Bluetooth system tray icon (on the bottom right corner of your computer screen):

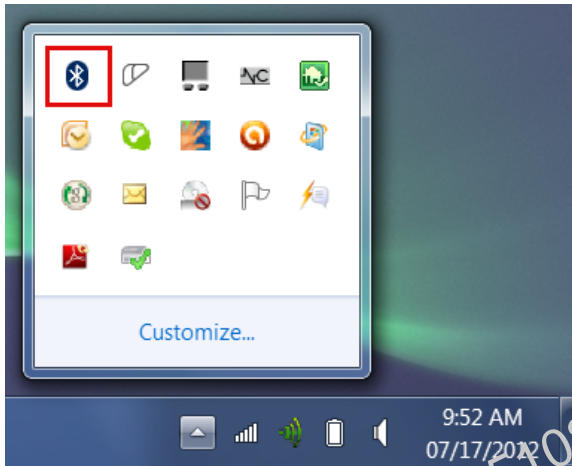

- b. The “Bluetooth Devices” window will be displayed:

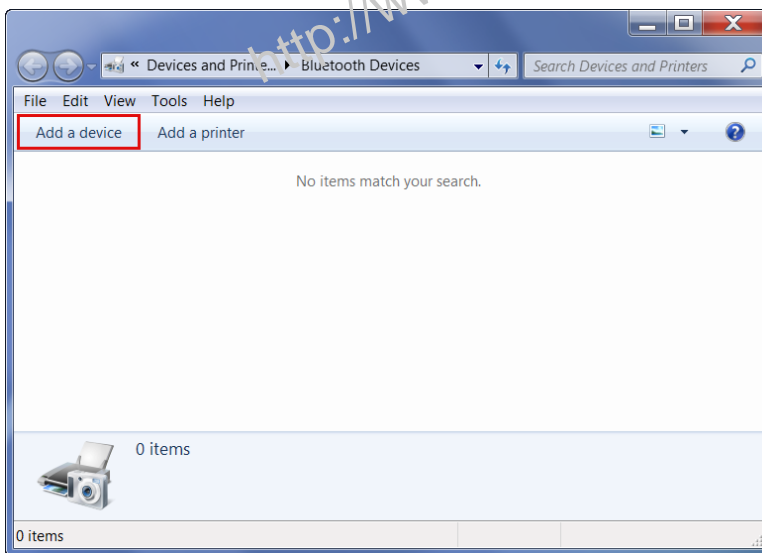

Click on “Add a device”.

- c. All nearby Bluetooth devices will be listed:

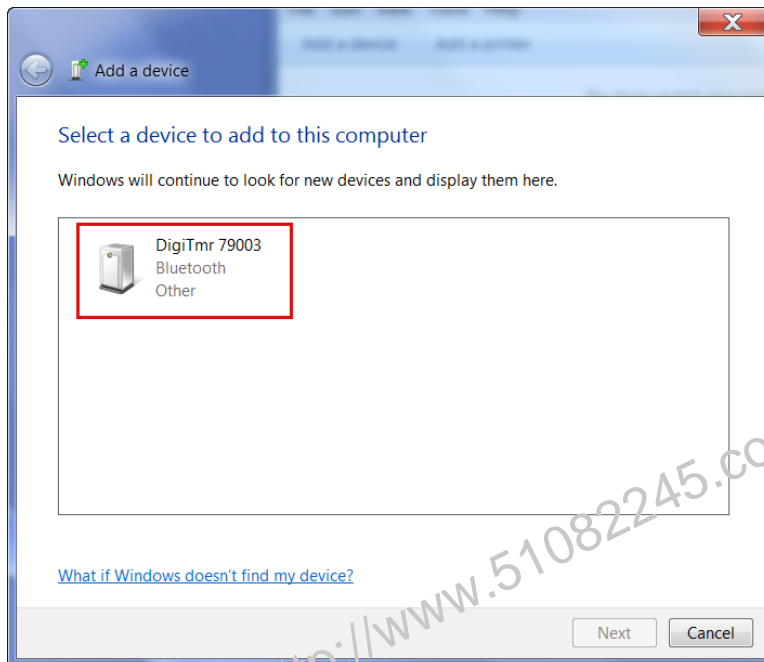

The DigiTMR S2 will be listed as “DigiTmr S/N” where S/N is the device’s serial number. Click on the icon for the DigiTMR and then click on the “Next” button.

- d. The device pairing screen will be displayed:

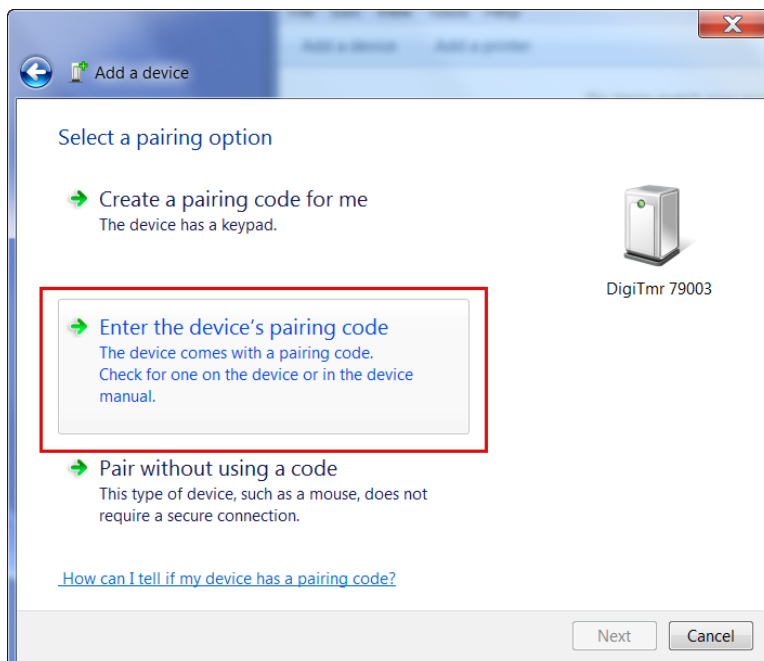

Click on “Enter the device’s pairing code” option.

- e. The following window will be displayed:

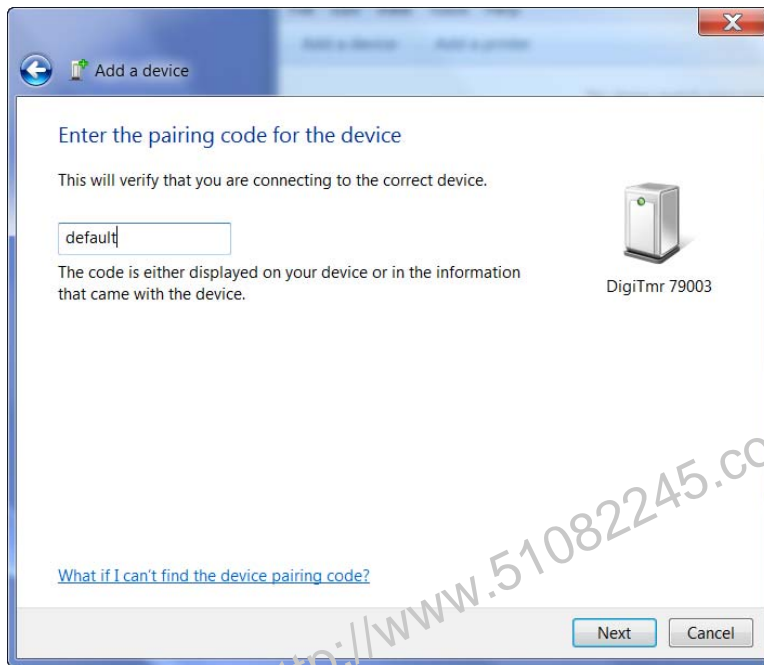

Type the word “default” (without the quotes and in all lower-case) in the text box and click on the “Next” button.

- f. The following screen will be displayed:

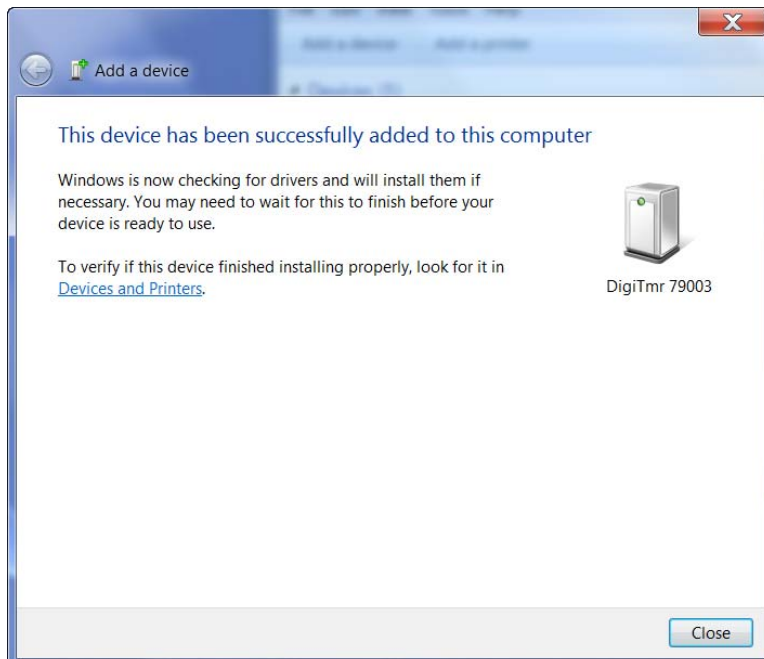

Click on the “Close” button.

g. The DigiTMR S2 will now be listed under “Bluetooth Devices”:

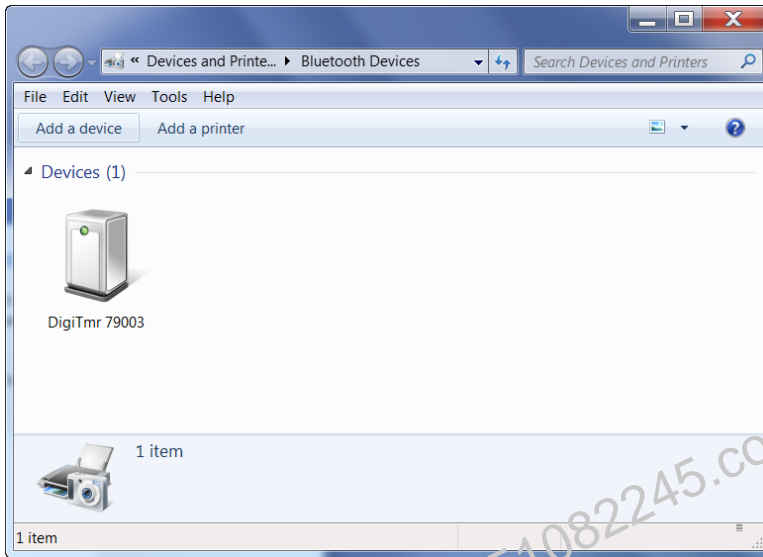

Right click on the DigiTmr icon and select “Properties” from the pop-up menu.

h. The properties window will be displayed. Click on the “Hardware” tab:

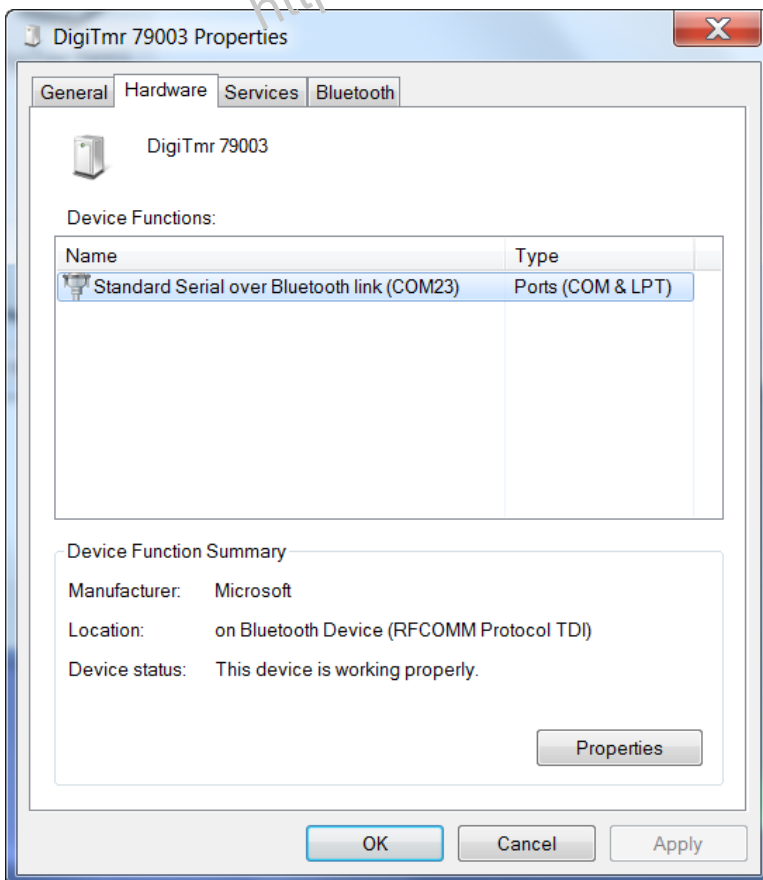

Note the port number listed after the device name (COM23 in the above example). Follow the directions in section **Error! Reference source not found.** to configure the VCBA S2 software to connect to the DigiTMR S2 using this COM port.

<http://www.51082245.com>



### 3.3 DigiTMR S2 Cable Connections

#### 3.3.1. Contact Cable Connections

A typical contact cable connection to a circuit breaker is shown in Figure 2. Red clips are connected to phase A, B, and C of the breaker's bushings. The black clips are connected to the ground or common side of the bushings. If the common side of the bushing is not grounded, jumpers should be installed between the bushings.



**NOTE**

It is advisable to ground one side of the contacts for most testing purposes. If a breaker is floating or ungrounded, ensure that the contact input channels are protected against static discharge.

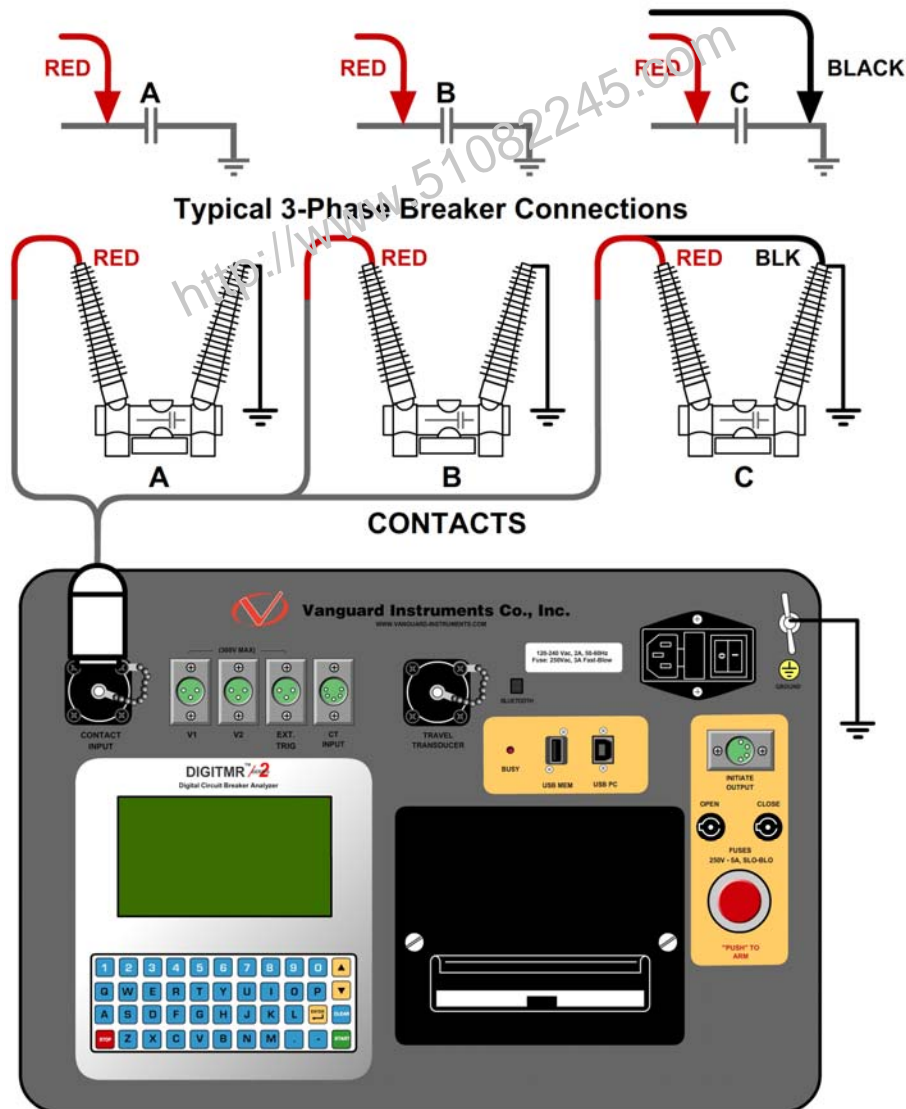

Figure 2. Contact Cable Connections

### 3.3.2. Initiate Cable Connections

The DigiTMR S2 will trip or close breakers through a solid-state device which will operate on any AC or DC control voltage ranging from 10 to 300 Volts. Both the trip and close circuits are protected by 5-Ampere fuses. A typical DC trip and DC close control circuit test connection is shown in Figure 3. A typical DC trip and AC close control circuit is shown in Figure 4.



**NOTE**

Always connect the initiate circuit with an auxiliary switch in series. The auxiliary switch provides the coil current interruption. Failure to follow this recommendation will damage the DigiTMR S2 initiate circuit.

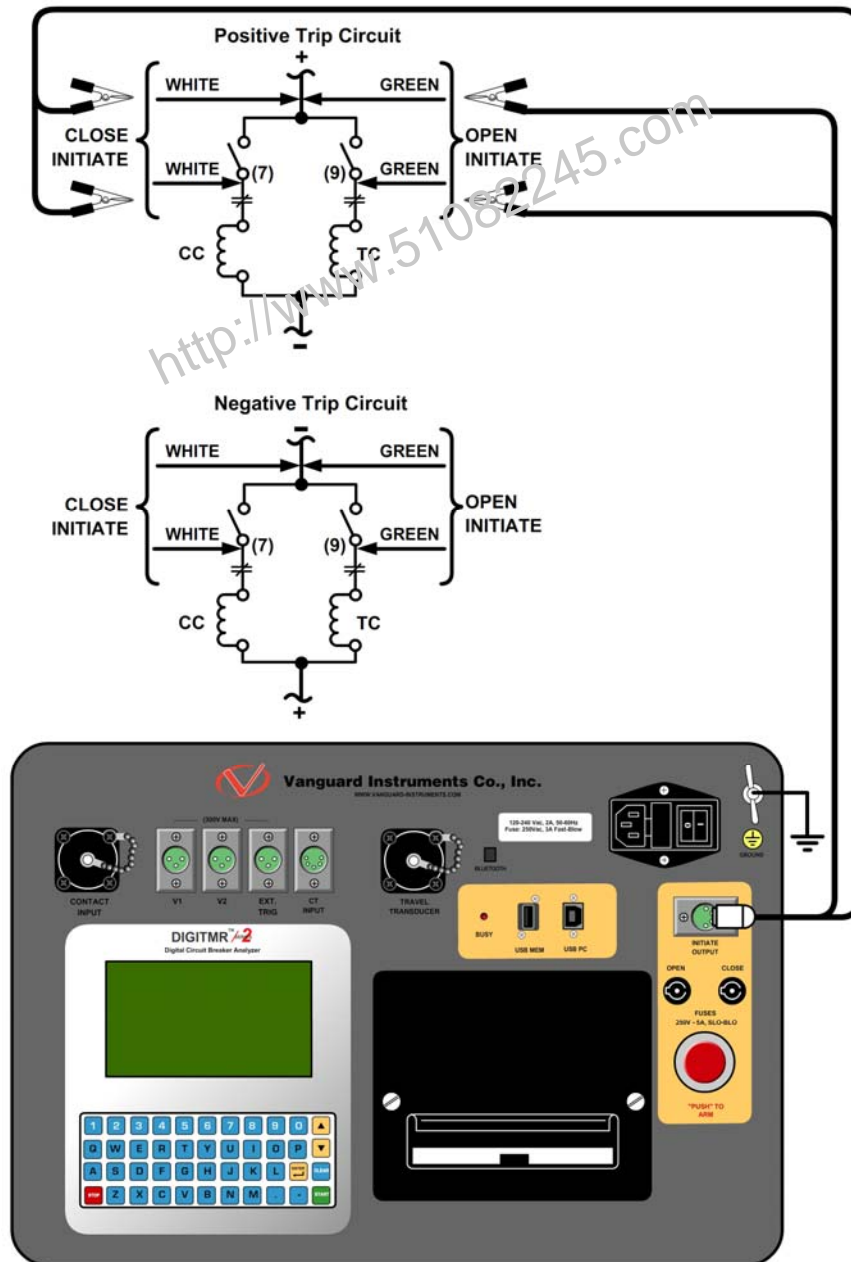

Figure 3. DC Trip and DC Close Initiate Circuit Cable Connections

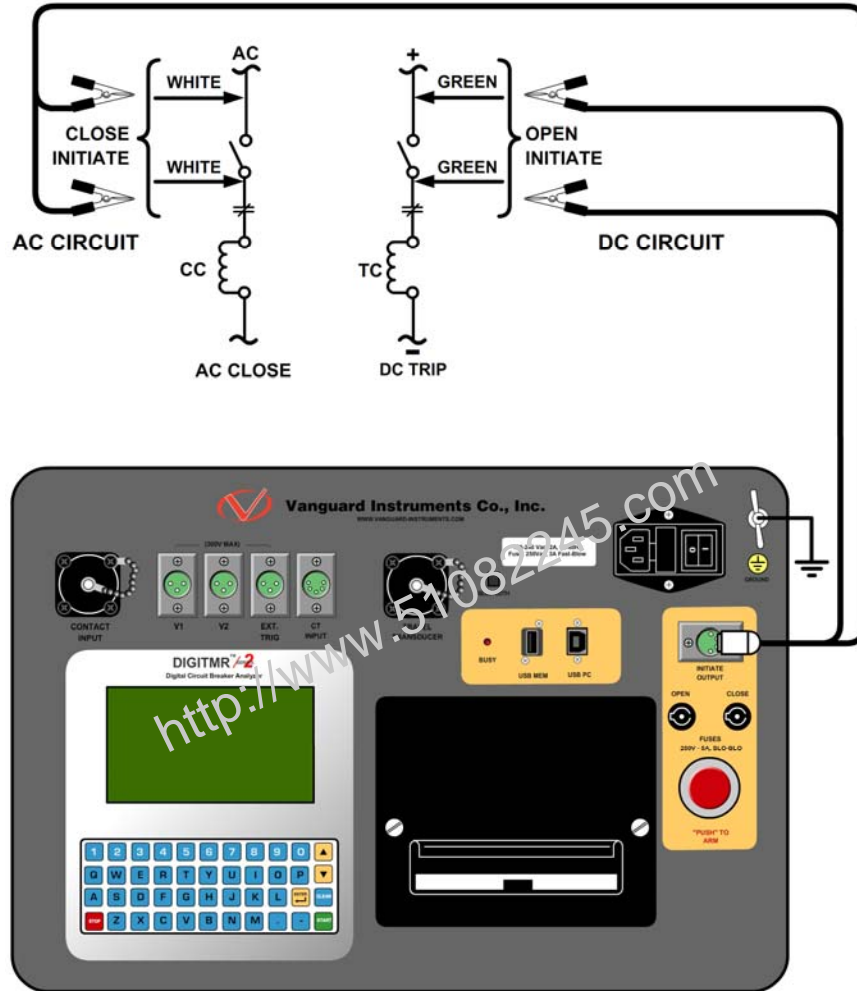

Figure 4. DC Trip and AC Close Initiate Circuit Cable Connections

### 3.3.3. Analog and Digital Voltage Monitor Connections

The analog voltage input “V1” is dedicated to monitoring a breaker’s DC control voltage during an operation. The analog input records the nominal DC voltage at no load and the minimum DC voltage while the Trip or Close coil is energized.

Nominal and minimum voltage readings can be printed on a tabulated report. Analog waveforms can also be plotted graphically. Using the reports, the user can see the breaker’s DC control voltage “dip” under load conditions and can easily detect problems such as a poor connection or an excessive voltage drop.

The digital voltage input “V2” monitors the voltage status as “ON” or “OFF” states and can graph the results.

A typical analog voltage monitoring connection (V1) and a typical digital monitoring connection (V2) are shown in Figure 5.



Maximum voltage recorded is 255 Vdc.

**NOTE**

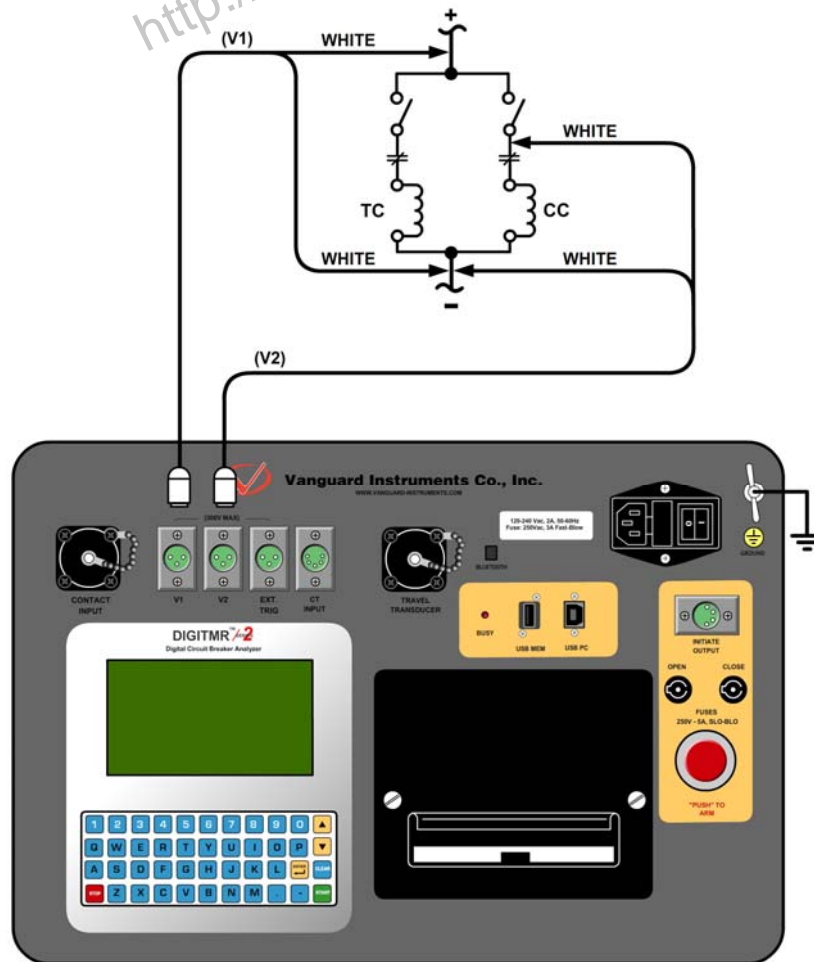

Figure 5. Analog and Digital Voltage Monitoring Cable Connections

### 3.3.4. External Trigger Input Connections

The External Trigger Mode can be used to start recording when the DigiTMR S2 senses a voltage (see Figure 6). This feature can be used to time a circuit breaker without using the initiate circuit (for example, if the initiate circuit is non-operational). Another typical application for the External Trigger Mode is to time a circuit breaker in a close operation and to start timing only when the close coil is energized, thus bypassing the 52Y relay delay time. The DigiTMR S2 will energize the 52Y relay to start the close operation and will then start timing when it senses the voltage across the closing coil. Please see Figure 7 for a typical test connection. Another application for the External Trigger Mode is to start timing the breaker when the user trips or closes the breaker remotely.



**NOTES**

- Minimum trigger voltage is set at 30 Vac/dc. Maximum continuous voltage is set at 300 Vac/dc.
- Different trigger voltages can be set at the factory based on specific user requests.
- The DigiTMR S2 will start looking for the external trigger voltage when the message “AWAITING TRIGGER...” is shown on the LCD. If the external trigger voltage is not sensed by the DigiTMR S2 within ten seconds after the initiate sequence has begun, the DigiTMR S2 will return to the main menu.

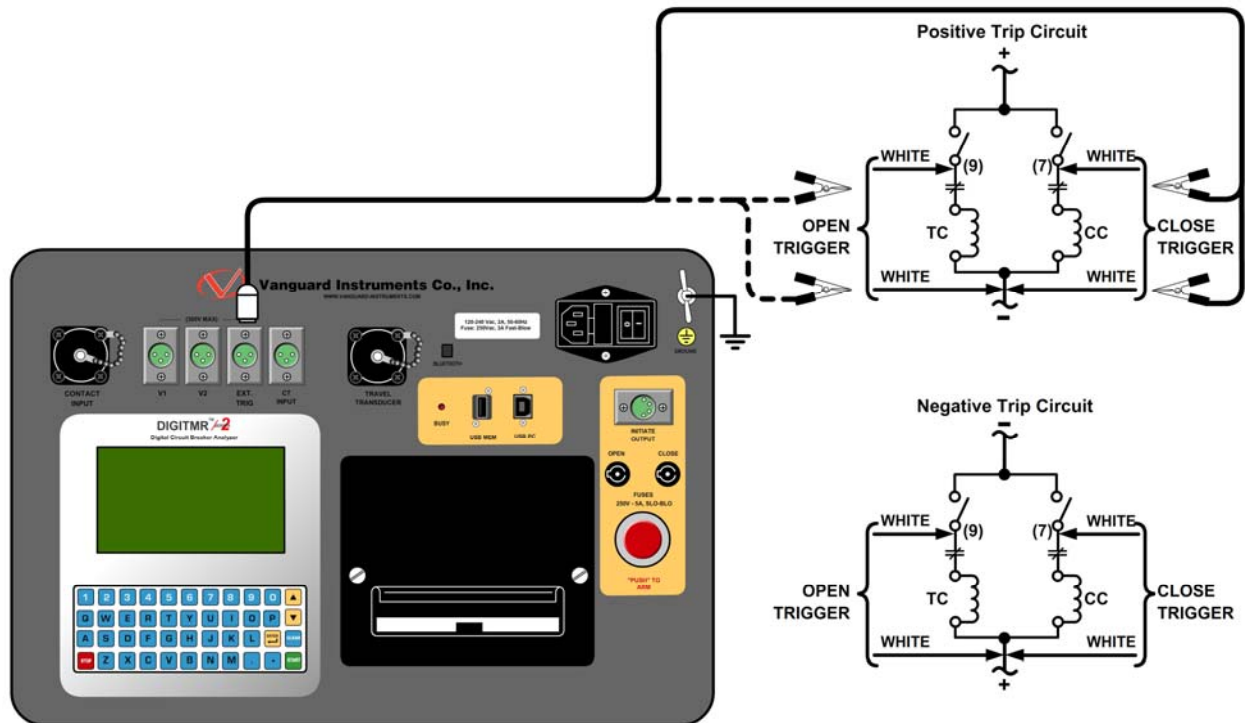

Figure 6. External Trigger Cable Connection for an Open Connection

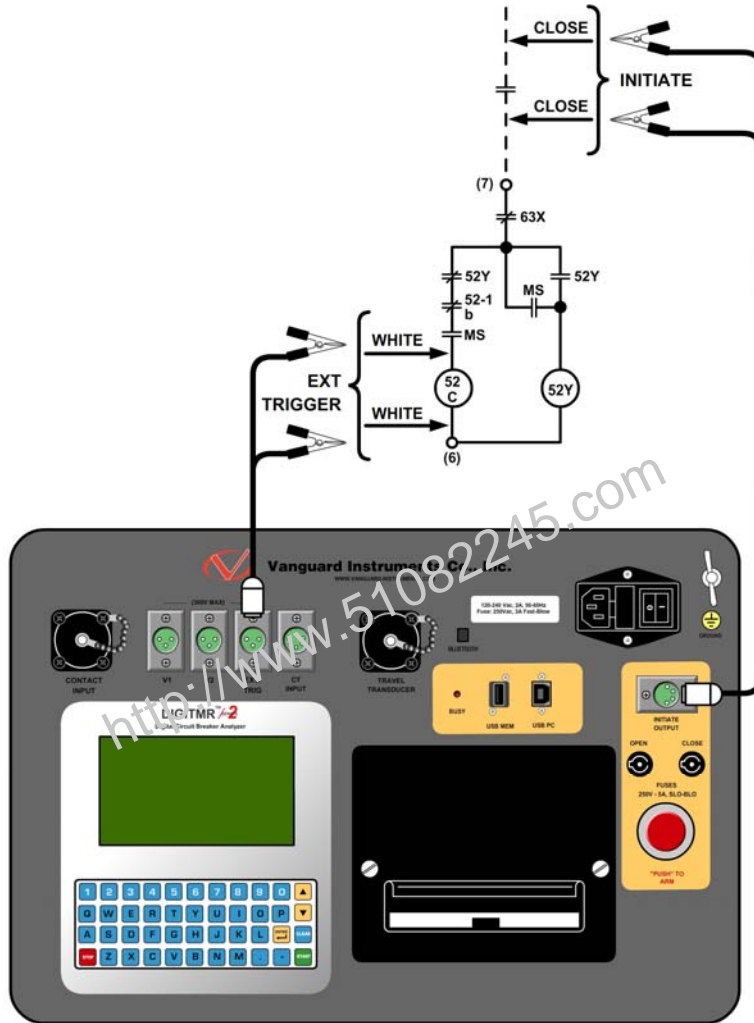

Figure 7. External Trigger on a Close Operation Less 52Y Delay Time

### 3.3.5. AC Current Sensor Connection

The DigiTMR S2 can sense a breaker's bushing current by using a clamp-on AC current sensor connected to the breaker's bushing CT. The AC current sensor is used in "On-Line" Mode only. The AC current sensor requires a minimum of 100 mA to operate. The maximum current is 25 Amperes. A typical AC sensor connection is shown in Figure 8.

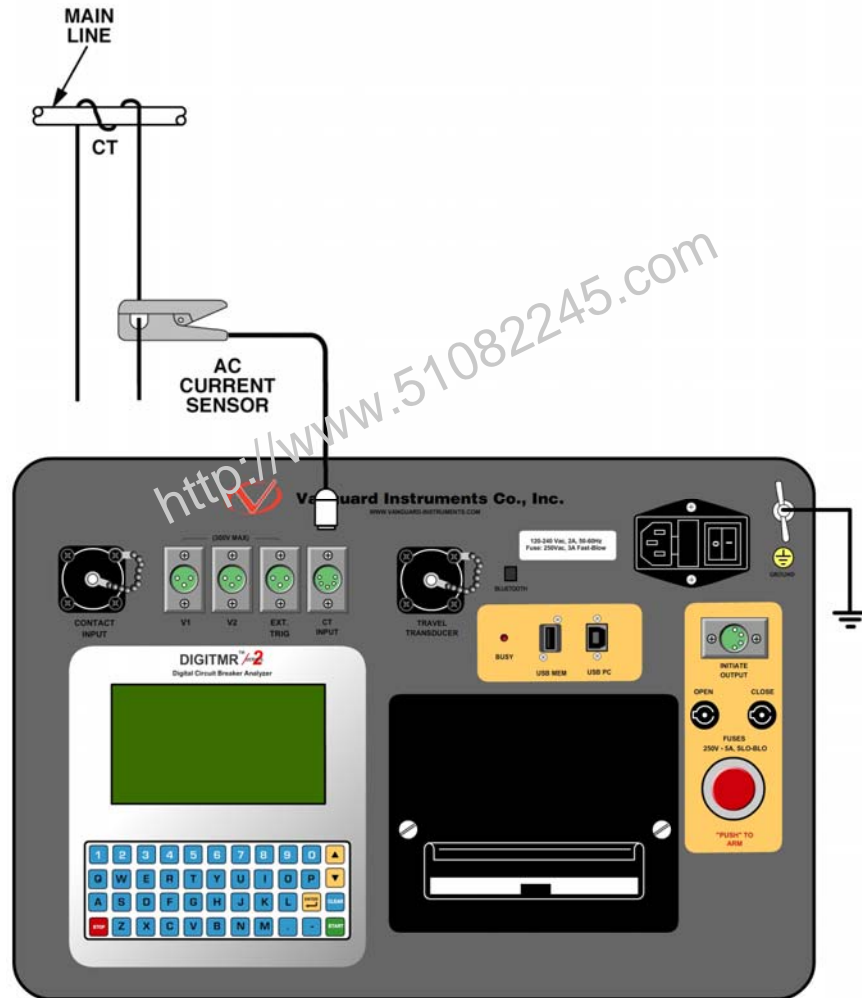

Figure 8. Typical CT Connection

### 3.3.6. Transducer Connections

A typical transducer connection is shown in Figure 9. See Appendix F for additional transducer illustrations.

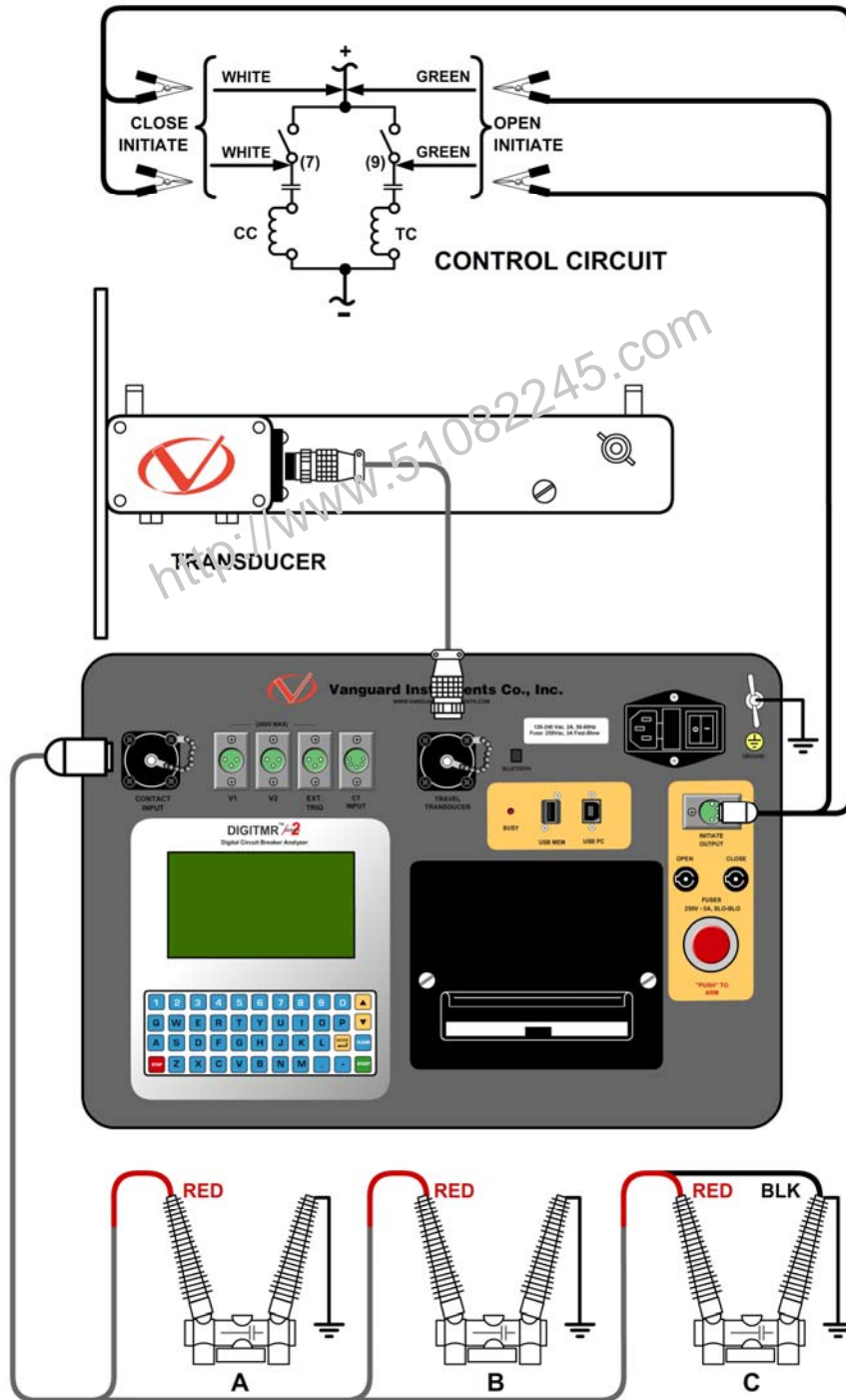

Figure 9. Typical Transducer Connection



The DigiTMR S2 can also be connected to a resistor type transducer such as the ABB AHMB (see Figure 10 and Figure 11) using the Vanguard Resistor Transducer Adapter (sold separately).

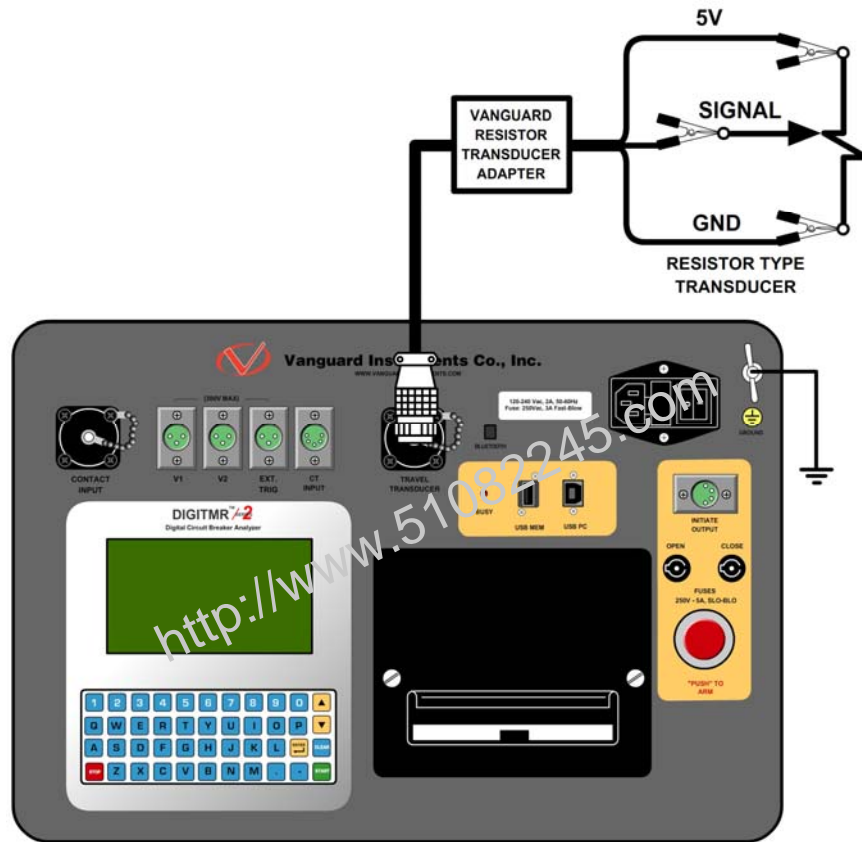

Figure 10. Typical Resistor Type Transducer Connection



Figure 11. Vanguard Resistor Transducer Adapter Connected to an ABB AHMB Transducer

The DigiTMR S2 can also be connected to Doble linear and rotary transducers using the optional Vanguard Doble Transducer adapter shown below.



Figure 12. Vanguard Doble Transducer Adapter Connected to a Doble TR3189 Linear Transducer

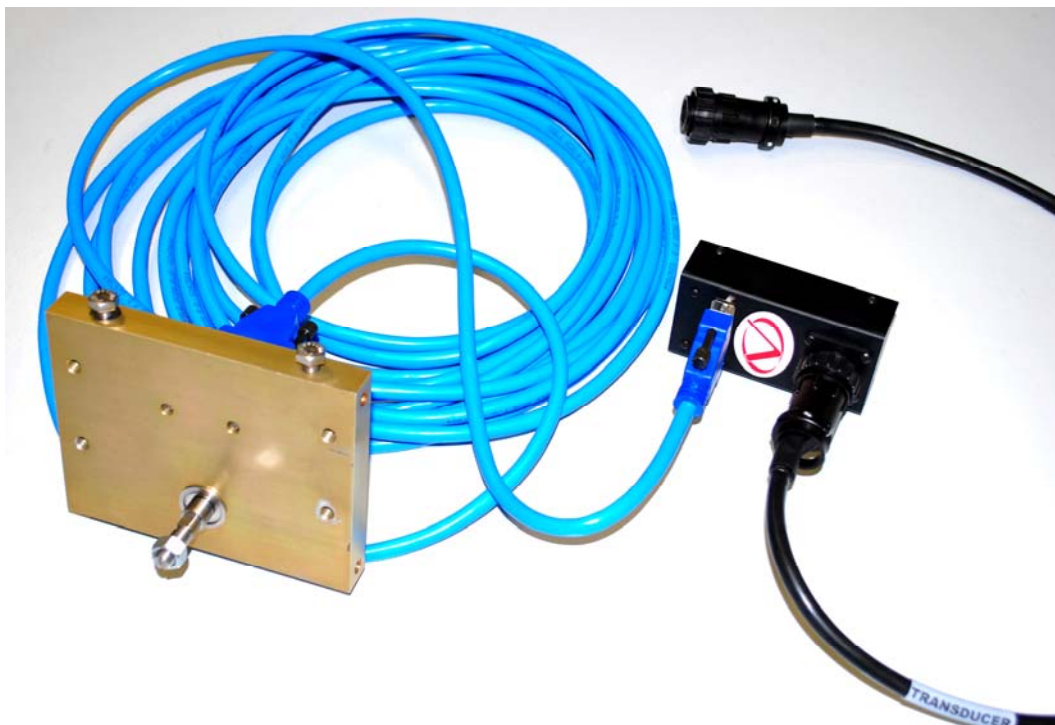

Figure 13. Vanguard Doble Transducer Adapter Connected to a Doble TR31170 Rotary Transducer

### 3.4 General Procedures and Configuration

The main steps for timing a circuit breaker are listed in Figure 14 below.

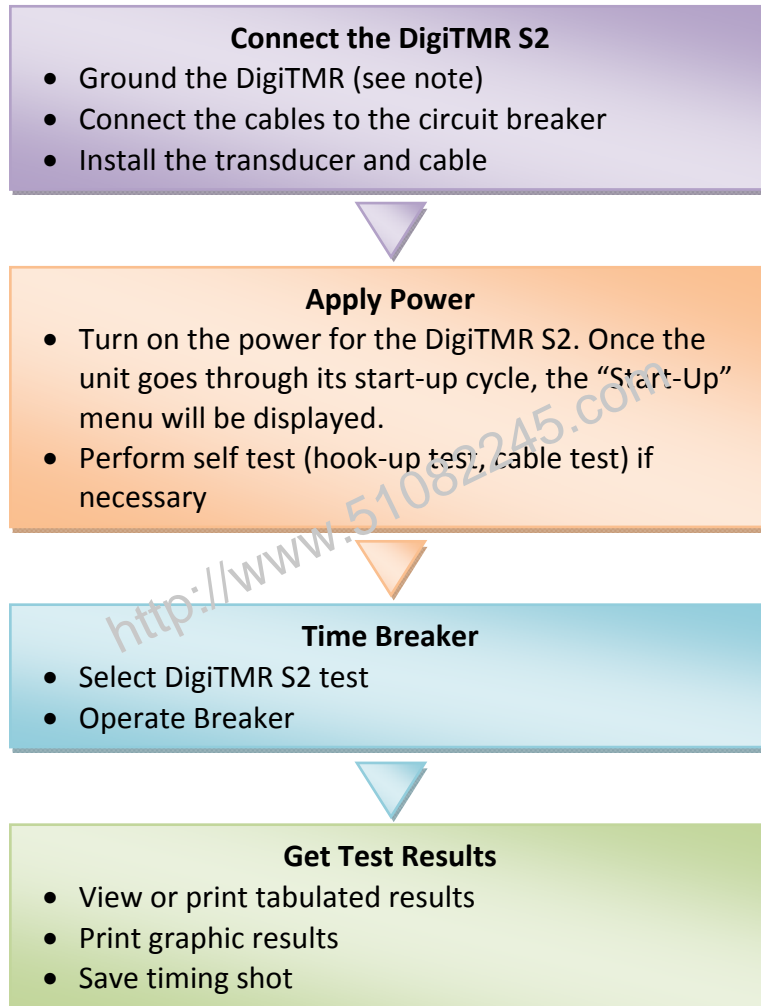

Figure 14. DigiTMR S2 General Operating Procedures



**NOTE**

To reduce the possibility of damaging the DigiTMR S2 due to static discharge in high voltage substations, it is recommended that one side of the breaker's bushings be grounded for the contact channels.

### 3.4.1. Setting the Interface Language

Follow the steps below to set the interface language (English, Spanish, or Turkish):

- a. Start from the "START-UP" menu:

```
1. TIME BREAKER
2. GET RESULTS
3. SETUP
4. DIAGNOSTICS
```

Press the **[3]** key (*SETUP*).

- b. The following screen will be displayed:

```
1. ANALYSIS POINTS
2. MEASUREMENT UNITS
3. SAVE / RESTORE
4. SHOT DESCRIPTION
5. NEXT PAGE
```

Press the **[5]** key (*NEXT PAGE*).

- c. The following screen will be displayed:

```
1. SET DATE & TIME
2. SET PRINT MODE
3. SET 50/60 HZ
4. SET LANGUAGE
5. BLUETOOTH DEV RESET
6. PREVIOUS PAGE
```

Press the **[4]** key (*SET LANGUAGE*).

- d. The following screen will be displayed:

```
1. ENGLISH
2. TURKISH
3. SPANISH
```

Select the preferred interface language by pressing the corresponding numeric key on the keypad. The interface language will be set and the following confirmation screen will be displayed:



Press any key to return to the "START-UP" menu.

<http://www.51082245.com>

### 3.4.2. Setting the Measurement Units

The DigiTMR S2 supports both English and Metric calculations from the breaker's travel parameters. Follow the steps below to change the measurement units:

- e. Start from the "START-UP" menu:

```
1. TIME BREAKER
2. GET RESULTS
3. SETUP
4. DIAGNOSTICS
```

Press the **[3]** key (*SET-UP*).

- f. The following screen will be displayed:

```
1. ANALYSIS POINTS
2. MEASUREMENT UNITS
3. SAVE / RESTORE
4. SHOT DESCRIPTION
5. NEXT PAGE
```

Press the **[2]** key (*MEASUREMENT UNITS*).

- g. The following screen will be displayed:

```
SELECT UNITS
1. ENGLISH
2. METRIC
3. ROTARY ENCODER
```



**NOTE**

When the measurement units are changed, the DigiTMR S2 will re-calculate the velocity and convert the readings of test shots to the new measurement units. For example, if a test shot was taken using the English measurement units and then the units of measure is changed to Metric, the velocity and test readings will be automatically converted to Metric.

1. *ENGLISH*

Press the **[1]** key (*ENGLISH*) for English measurement units. The measurement units will be set to English, and you will be returned to the "START-UP" menu.

## 2. METRIC

Press the **[2]** key (*METRIC*) for Metric measurement units. The measurement units will be set to Metric, and you will be returned to the "START-UP" menu.

## 3. ROTARY ENCODER

Press the **[3]** key (*ROTARY ENCODER*) if you would like to set the measurement units for the rotary encoder.



### NOTE

If a rotary encoder (transducer) is used, the correct "distance/degree" value must be entered before timing the circuit breaker.

The following screen will be displayed:



### 1) ENGLISH (IN./DEG)

Press the **[1]** key (*ENGLISH*) for English measurement units. The following screen will be displayed:

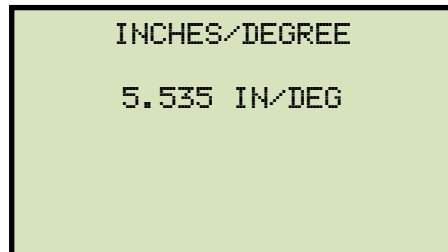

If the value displayed is not correct, press the **[CLEAR]** key, and then type the desired value using the keypad. Press the **[ENTER]** key and you will be returned to the "START-UP" menu.

### 2) METRIC (MM/DEG)

Press the **[2]** key (*METRIC*) for Metric measurement units. The following screen will be displayed:

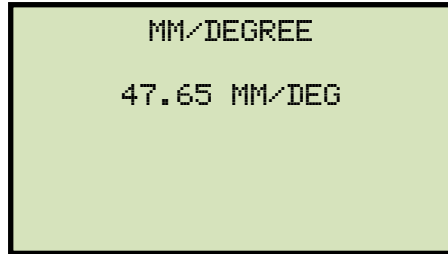

If the value displayed is not correct, press the **[CLEAR]** key, and then type the desired value using the keypad. Press the **[ENTER]** key and you will be returned to the "START-UP" menu.

<http://www.51082245.com>



### 3.4.3. Setting the DigiTMR S2's Internal Clock

The DigiTMR S2 has an internal clock with a lithium battery. The battery lasts approximately three years. When a timing shot is stored, the time and date are also stored with the shot.

Follow the steps below to set the unit's internal clock:

- a. Start from the "START-UP" menu:

```
1. TIME BREAKER
2. GET RESULTS
3. SETUP
4. DIAGNOSTICS
```

Press the **[3]** key (*SET-UP*).

- b. The following screen will be displayed:

```
1. ANALYSIS POINTS
2. MEASUREMENT UNITS
3. SAVE / RESTORE
4. SHOT DESCRIPTION
5. NEXT PAGE
```

Press the **[5]** key (*NEXT PAGE*).

- c. The following screen will be displayed:

```
1. SET DATE & TIME
2. SET PRINT MODE
3. SET 50/60 HZ
4. SET LANGUAGE
5. BLUETOOTH DEV RESET
6. PREVIOUS PAGE
```

Press the **[1]** key (*SET DATE & TIME*)

- d. The following screen will be displayed:

```
ENTER DATE

MM-DD-YY
```

Type the date using the keypad.

- e. The following screen will be displayed:



Type the time (in 24-hour format) using the keypad. The date and time will be set and you will be returned to the "START-UP" menu.

<http://www.51082245.com>

### 3.4.4. Entering Test Record Header Information

You can enter the test record header information before performing tests. The record header includes identifying information such as the company, station, circuit, manufacturer, etc. Once the header information has been set, it will apply to all subsequent test records. Follow the steps below to enter the test header information:

- a. Start from the "START-UP" menu:

```
1. TIME BREAKER
2. GET RESULTS
3. SETUP
4. DIAGNOSTICS
```

Press the **[3]** key (*SET-UP*).

- b. The following screen will be displayed:

```
1. ANALYSIS POINTS
2. MEASUREMENT UNITS
3. SAVE / RESTORE
4. SHOT DESCRIPTION
5. NEXT PAGE
```

Press the **[4]** key (*SHOT DESCRIPTION*).

- c. The following screen will be displayed:

```
COMPANY:
-
↑/↓ TO POSITION
"ENTER" TO ACCEPT
```

Type the company name using the keypad. Press the **[ENTER]** key when you are done typing the company name.

- d. The following screen will be displayed:

```
STATION:  
-  
  
↑/↓ TO POSITION  
"ENTER" TO ACCEPT
```

Type the station name using the keypad and then press the **[ENTER]** key.

- e. The following screen will be displayed:

```
CIRCUIT:  
-  
  
↑/↓ TO POSITION  
"ENTER" TO ACCEPT
```

Type the circuit information using the keypad and then press the **[ENTER]** key.

- f. The following screen will be displayed:

```
MANUFACTURER:  
-  
  
↑/↓ TO POSITION  
"ENTER" TO ACCEPT
```

Type the manufacturer name using the keypad and then press the **[ENTER]** key.

- g. The following screen will be displayed:

```
MODEL:  
-  
  
↑/↓ TO POSITION  
"ENTER" TO ACCEPT
```

Type the circuit breaker's model information using the keypad and then press the **[ENTER]** key.

- h. The following screen will be displayed:

```
SERIAL NUMBER:  
-  
↑/↓ TO POSITION  
"ENTER" TO ACCEPT
```

Type the circuit breaker's serial number using the keypad and then press the **[ENTER]** key.

- i. The following screen will be displayed:

```
OPERATOR:  
-  
↑/↓ TO POSITION  
"ENTER" TO ACCEPT
```

Type the operator's name using the keypad and then press the **[ENTER]** key. All header information will be saved, and you will be returned to the "START-UP" menu.

### 3.4.5. Setting the Frequency

Follow the steps below to set the frequency (50 or 60 Hz):

- a. Start from the "START-UP" menu:

```
1. TIME BREAKER
2. GET RESULTS
3. SETUP
4. DIAGNOSTICS
```

Press the **[3]** key (*SET-UP*).

- b. The following screen will be displayed:

```
1. ANALYSIS POINTS
2. MEASUREMENT UNITS
3. SAVE / RESTORE
4. SHOT DESCRIPTION
5. NEXT PAGE
```

Press the **[5]** key (*NEXT PAGE*).

- c. The following screen will be displayed:

```
1. SET DATE & TIME
2. SET PRINT MODE
3. SET 50/60 HZ
4. SET LANGUAGE
5. BLUETOOTH DEV RESET
6. PREVIOUS PAGE
```

Press the **[3]** key (*SET 50/60 HZ*).

- d. The following screen will be displayed:

```
1. SET 50 HZ
2. SET 60 HZ
```

Select the preferred frequency by pressing the corresponding key on the keypad (**[1]** for 50 Hz or **[2]** for 60 Hz). The frequency will be set and the following confirmation screen will be displayed:

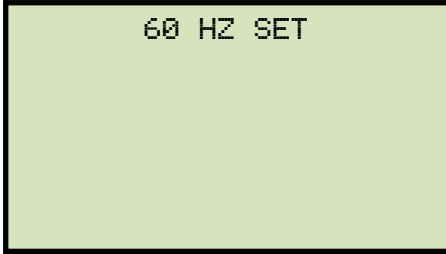

Press any key to return to the "START-UP" menu.

<http://www.51082245.com>

### 3.4.6. Setting the Default Printing Mode

The DigiTMR S2 can be configured to either print the test results automatically after each test, or to print them by user request. Use the steps below to set the preferred printing method:

- a. Start from the "START-UP" menu:

```
1. TIME BREAKER
2. GET RESULTS
3. SETUP
4. DIAGNOSTICS
```

Press the **[3]** key (*SET-UP*).

- b. The following screen will be displayed:

```
1. ANALYSIS POINTS
2. MEASUREMENT UNITS
3. SAVE / RESTORE
4. SHOT DESCRIPTION
5. NEXT PAGE
```

Press the **[5]** key (*NEXT PAGE*).

- c. The following screen will be displayed:

```
1. SET DATE & TIME
2. SET PRINT MODE
3. SET 50/60 HZ
4. SET LANGUAGE
5. BLUETOOTH DEV RESET
6. PREVIOUS PAGE
```

Press the **[2]** key (*SET PRINT MODE*).

- d. The following screen will be displayed:

```
SET PRINT MODE:
1. AUTOMATIC PRINT
2. BY REQUEST ONLY
```



1. *AUTOMATIC PRINT*

Press the **[1]** key (*AUTOMATIC PRINT*) if you would like reports to be printed automatically after each test. The setting will be saved and you will be returned to the "START-UP" menu.

2. *BY REQUEST ONLY*

Press the **[2]** key (*BY REQUEST ONLY*) if you do not want test reports to be printed automatically after each test. The setting will be saved and you will be returned to the "START-UP" menu. Please see section 3.9 for information on how to print test shots.

<http://www.51082245.com>

### 3.5 Timing Breakers in On-line Mode

In On-line mode, the DigiTMR S2 can only provide OPEN or CLOSE times using the CT input channel. The DigiTMR S2 can initiate the OPEN or CLOSE tests, and then the test report will show the OPEN or CLOSE coil current reading and waveform. If the DigiTMR S2 is operated in On-line mode using the External Trigger, no coil current reading or waveform will be recorded.

### 3.6 Timing Breakers in Time-Travel Mode

The DigiTMR S2 can initiate the breaker operation and perform a timing test on the following operations:

- OPEN
- CLOSE
- OPEN-CLOSE
- CLOSE-OPEN
- OPEN-CLOSE-OPEN



#### NOTES

- The DigiTMR S2 can start the OPEN-CLOSE operations without a delay or by using a programmable delay between the OPEN and CLOSE commands.
- The CLOSE-OPEN operation can be started by the DigiTMR S2 using several options:
  - Contact #1 Close  
The DigiTMR S2 can initiate a CLOSE command and then an OPEN command after detecting that the breaker's contact was closed. The DigiTMR S2 can detect when the breaker's contact is closed via contact channel #1. The selection of this option is recommended for the CLOSE-OPEN operation since it truly represents that the circuit breaker closed and then opened.
  - Set DELAY  
The DigiTMR S2 can initiate a CLOSE command and then an OPEN command after a programmable delay (in milliseconds).
  - No DELAY  
The DigiTMR S2 can initiate a CLOSE command and then an OPEN command without a delay. Since the circuit breaker is in the open state, the circuit breaker's 52B contact allows the close coil to be energized, which can start the close command. When the circuit breaker is making the transition from an open state to a close state, the 52A contact will close, allowing the breaker to initiate the open command.
- The OPEN-CLOSE-OPEN operations can be initiated by the DigiTMR S2 using a programmable delay between each of the operations. The delays can be set between the OPEN to CLOSE and between the CLOSE to OPEN operations.

### 3.7 Performing Timing Tests

#### 3.7.1. Timing an OPEN Operation With No Insertion Resistors

To time an OPEN operation with no insertion resistors:

- e. Start from the "START-UP" menu:

```

1. TIME BREAKER
2. GET RESULTS
3. SETUP
4. DIAGNOSTICS

```

Press the **[1]** key (*TIME BREAKER*) to start a test.

If a previous test shot is in the DigiTMR S2's memory, the following screen will be displayed:

```

PREV SHOT NOT SAVED
1. SAVE SHOT
2. CONTINUE (NO SAVE)

```

1. *SAVE SHOT*

If you would like to save the previous shot in memory, press the **[1]** key (*SAVE SHOT*). The following screen will be displayed:

```

SAVE SHOT #    2
TEST: OPEN
DATE: 07/09/12 08:18

"ENTER" TO PROCEED

```

Press the [ENTER] key. The following screen will be displayed:

```

SAVE IN PROGRESS

PLEASE WAIT

```

Once the record is saved, the following screen will be displayed:



Press any key on the keypad and you will be returned to the “START-UP” menu.  
Re-start at step a.

2. *CONTINUE (NO SAVE)*

If you do not wish to save the test shot in memory, press the **[2]** key, and then **continue to step b.**

f. The following screen will be displayed:



Press the **[1]** key (*NO*) to indicate that there is no insertion resistor.

g. The following screen will be displayed:

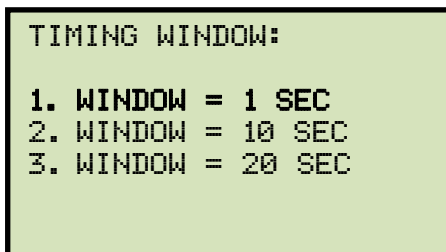

Press the **[1]** key (*WINDOW = 1 SEC*) to select the 1-second timing window.



- The 1-second timing window is used for breaker timing. The 10-second and 20-second timing windows are used for circuit-switcher timing.
- NOTES**
- Using the 10 second timing window will reduce the timing resolution to 0.5 ms.
  - Using the 20 second timing window will reduce the timing resolution to 1 ms.

- h. The following screen will be displayed:

```
TRIGGER MODE:  
  
1. INTERNAL TRIGGER  
2. EXTERNAL TRIGGER
```

Press the **[1]** key (*Internal Trigger*) to select the internal trigger.

- i. The following screen will be displayed:

```
TIMING MODE:  
  
1. OPEN      2. CLOSE  
3. O-C      4. C-O  
5. O-C-O
```

Press the **[1]** key (*OPEN*) to select the OPEN timing operation.

- j. The following screen will be displayed:

```
HOLD "ARM" UNTIL  
TEST COMPLETES  
  
"START" TO BEGIN  
"STOP" TO ABORT
```

Press and hold down the **[ARM]** switch, and then press the **[START]** key. Continue to hold down the **[ARM]** switch.

- k. The following screen will be displayed during testing:

```
TEST IN PROGRESS  
HOLD "ARM" UNTIL  
TEST COMPLETES.  
(UP TO 25 SECONDS)
```

Continue to hold down the **[ARM]** switch until the test is completed.

- l. Once the test is completed, you will be returned to the "START-UP" menu.  
Please see section 3.9 for instructions on how to print the test results.

**NOTE**

The DigiTMR S2 can be configured to print tabulated and graphic reports automatically after a test is completed. Please see section 3.4.6 for further information.

<http://www.51082245.com>

### 3.7.2. Timing an OPEN Operation WITH Insertion Resistors

The DigiTMR S2 can time breakers with insertion resistors. The insertion resistor can range from 10 to 7,000 Ohms. Any insertion resistor greater than 7,000 Ohms is detected as an open circuit. When a breaker with insertion resistors is timed, the timing window results show the main contact timing and the insertion resistor contact timing. The graphic reports also show the main and the resistor contact activities on each of the channels. To time an OPEN operation with insertion resistors:

- a. Start from the "START-UP" menu:

```
1. TIME BREAKER
2. GET RESULTS
3. SETUP
4. DIAGNOSTICS
```

Press the **[1]** key (*TIME BREAKER*) to start a test.

- b. The following screen will be displayed:

```
INSERTION RESISTOR?
1. NO
2. YES
```

Press the **[2]** key (*YES*).

- c. The following screen will be displayed:

```
RESISTOR VALUE:
1. LESS THAN 1000 OHMS
2. 1000 TO 2000 OHMS
3. MORE THAN 2000 OHMS
```

Select the resistor value by pressing the corresponding key (**[1]**, **[2]**, or **[3]**).

- d. The following screen will be displayed:

```
TIMING WINDOW:  
  
1. WINDOW = 1 SEC  
2. WINDOW = 10 SEC  
3. WINDOW = 20 SEC
```

Press the **[1]** key (*WINDOW = 1 SEC*) to select the 1-second timing window.

- e. The following screen will be displayed:

```
TRIGGER MODE:  
  
1. INTERNAL TRIGGER  
2. EXTERNAL TRIGGER
```

Press the **[1]** key (*Internal Trigger*) to select the internal trigger.

- f. The following screen will be displayed:

```
TIMING MODE:  
  
1. OPEN      2. CLOSE  
3. O-C      4. C-O  
5. O-C-O
```

Press the **[1]** key (*OPEN*) to select the OPEN timing operation.

- g. The following screen will be displayed:

```
HOLD "ARM" UNTIL  
TEST COMPLETES  
  
"START" TO BEGIN  
"STOP" TO ABORT
```

Press and hold down the **[ARM]** switch, and then press the **[START]** key. Continue to hold down the **[ARM]** switch.



- h. The following screen will be displayed during testing:

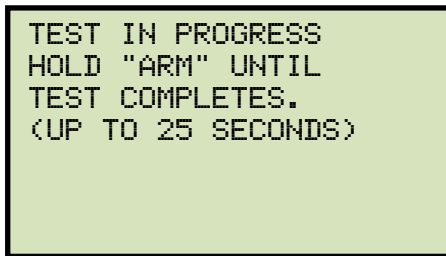

```
TEST IN PROGRESS
HOLD "ARM" UNTIL
TEST COMPLETES.
(UP TO 25 SECONDS)
```

Continue to hold down the **[ARM]** switch until the test is completed.

- i. Once the test is completed, you will be returned to the "START-UP" menu.

<http://www.51082245.com>

### 3.7.3. Timing a CLOSE-OPEN Operation Using Contact Channel #1

The CLOSE-OPEN operation of a breaker simulates a condition where a breaker is closed on a fault. To time a CLOSE-OPEN operation:

- a. Start from the "START-UP" menu:

```
1. TIME BREAKER
2. GET RESULTS
3. SETUP
4. DIAGNOSTICS
```

Press the **[1]** key (*TIME BREAKER*) to start a test.

- b. The following screen will be displayed:

```
INSERTION RESISTOR?
1. NO
2. YES
```

Press the **[1]** key (*NO*).

- c. The following screen will be displayed:

```
TIMING WINDOW:
1. WINDOW = 1 SEC
2. WINDOW = 10 SEC
3. WINDOW = 20 SEC
```

Press the **[1]** key (*WINDOW = 1 SEC*) to select the 1-second timing window.

- d. The following screen will be displayed:

```
TRIGGER MODE:
1. INTERNAL TRIGGER
2. EXTERNAL TRIGGER
```

Press the **[1]** key (*Internal Trigger*) to select the internal trigger.

- e. The following screen will be displayed:

```
TIMING MODE:
1. OPEN      2. CLOSE
3. O-C      4. C-O
5. O-C-O
```

Press the **[4]** key (C-O) to select the CLOSE-OPEN timing operation.

- f. The following screen will be displayed:

```
C-O SECOND TRIGGER
1. CONTACT #1 CLOSE
2. SET DELAY
3. NO DELAY
```

Press the **[1]** key (Contact #1 CLOSE).



#### Option details

#### NOTES

- **Contact #1 CLOSE**

The open operation is initiated after contact channel #1 is closed. If this option is selected, the DigiTMR S2 will first initiate a CLOSE command and then send an OPEN command only when it detects that the main contact #1 is closed. This mode accurately simulates the closing of a breaker on a fault condition.

- **Set DELAY**

A delay from 10 to 500 milliseconds can be set between the CLOSE and OPEN command. When a delay is used in the operation, it may not represent a true breaker operating condition.

- **No DELAY**

Both the CLOSE and OPEN commands are initiated by the DigiTMR S2 simultaneously.

- g. The following screen will be displayed:

```
HOLD "ARM" UNTIL
TEST COMPLETES

"START" TO BEGIN
"STOP" TO ABORT
```

Press and hold down the **[ARM]** switch, and then press the **[START]** key. Continue to hold down the **[ARM]** switch.

- h. The following screen will be displayed during testing:

```
TEST IN PROGRESS
HOLD "ARM" UNTIL
TEST COMPLETES.
<UP TO 25 SECONDS>
```

Continue to hold down the **[ARM]** switch until the test is completed.

- i. Once the test is completed, you will be returned to the "START-UP" menu.

<http://www.51082245.com>

### 3.7.4. Timing an OPEN-CLOSE-OPEN Operation

To time an OPEN-CLOSE-OPEN operation:

- a. Start from the "START-UP" menu:

```
1. TIME BREAKER
2. GET RESULTS
3. SETUP
4. DIAGNOSTICS
```

Press the **[1]** key (*TIME BREAKER*) to start a test.

- b. The following screen will be displayed:

```
INSERTION RESISTOR?
1. NO
2. YES
```

Press the **[1]** key (*NO*).

- c. The following screen will be displayed:

```
TIMING WINDOW:
1. WINDOW = 1 SEC
2. WINDOW = 10 SEC
3. WINDOW = 20 SEC
```

Press the **[1]** key (*WINDOW = 1 SEC*) to select the 1-second timing window.

- d. The following screen will be displayed:

```
TRIGGER MODE:
1. INTERNAL TRIGGER
2. EXTERNAL TRIGGER
```

Press the **[1]** key (*INTERNAL TRIGGER*) to select the internal trigger.

- e. The following screen will be displayed:

```
TIMING MODE:  
1. OPEN      2. CLOSE  
3. O-C      4. C-O  
5. O-C-O
```

Press the **[5]** key (O-C-O) to select the OPEN-CLOSE-OPEN timing operation.

- f. The following screen will be displayed:

```
O-C DELAY IN MS:  
  
  (10 - 350)  
      MSEC  
  
"ENTER" WHEN DONE
```

Using the keypad, enter the delay time (in milliseconds) between the OPEN-CLOSE operation, and then press the **[ENTER]** key.

- g. The following screen will be displayed:

```
C-O DELAY IN MS:  
  
  (10 - 350)  
      MSEC  
  
"ENTER" WHEN DONE
```

Using the keypad, enter the delay time (in milliseconds) between the CLOSE-OPEN operation, and then press the **[ENTER]** key.

- h. The following screen will be displayed:

```
HOLD "ARM" UNTIL  
TEST COMPLETES  
  
"START" TO BEGIN  
"STOP" TO ABORT
```

Press and hold down the **[ARM]** switch, and then press the **[START]** key. Continue to hold down the **[ARM]** switch.

- i. The following screen will be displayed during testing:

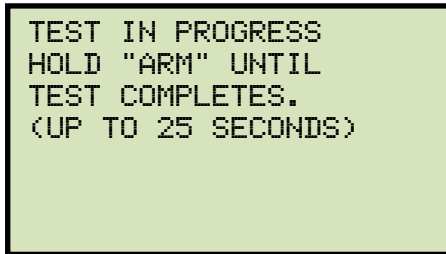

```
TEST IN PROGRESS
HOLD "ARM" UNTIL
TEST COMPLETES.
<UP TO 25 SECONDS>
```

Continue to hold down the **[ARM]** switch until the test is completed. Once the test is completed, you will be returned to the "START-UP" menu.

<http://www.51082245.com>

## 3.8 Performing Diagnostic Tests

### 3.8.1. Performing a Slow-Close Test

The DigiTMR S2 offers a unique feature called a “Slow-Close” test. This test can measure the distance of a breaker’s contact travel from the fully open position to the contact “touch” position and contact wipe, or penetration distance. The test requires the operator to manually jack the breaker’s contact from the fully open position to the fully closed position.

Contact channels 1, 2, and 3 and the transducer channel 1 are used for the “Slow-Close” test. The DigiTMR S2 measures the contact touch and contact wipe for each contact channel.

Contact touch is the distance measured from the contact fully open to the first position where the contact channel is electrically closed. Contact wipe, or penetration, is the distance measured from the contact position first electrically closed to the final closed, latching position.

To perform a “Slow-Close” test:

- a. Start from the “START-UP” menu:

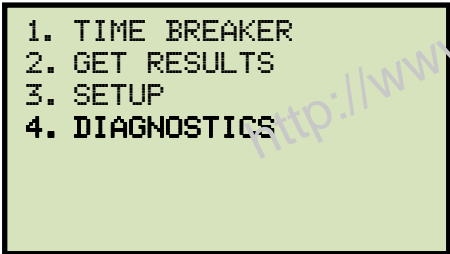

```
1. TIME BREAKER
2. GET RESULTS
3. SETUP
4. DIAGNOSTICS
```

Press the **[4]** key (*DIAGNOSTICS*).

- b. The following screen will be displayed:

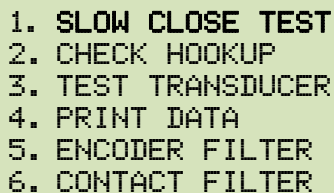

```
1. SLOW CLOSE TEST
2. CHECK HOOKUP
3. TEST TRANSDUCER
4. PRINT DATA
5. ENCODER FILTER
6. CONTACT FILTER
```

Press the **[1]** key (*SLOW CLOSE TEST*).

- c. The following screen will be displayed:

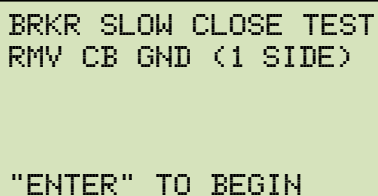

```
BRKR SLOW CLOSE TEST
RMV CB GND (1 SIDE)

"ENTER" TO BEGIN
```

Press the **[ENTER]** key.



- d. The following screen will be displayed:

```
CONTACT 1: OPEN
CONTACT 2: OPEN
CONTACT 3: OPEN

LIFT TO CLS BRKR NOW
```

Manually close the breaker. As each contact is closed, the screen will be updated as shown:

```
CONTACT 1: CLOSED
CONTACT 2: CLOSED
CONTACT 3: OPEN

LIFT TO CLS BRKR NOW
```

After all of the contacts have been closed, the following screen will be displayed:

```
LIFT BRKR TO CLS POS
THEN PRESS "ENTER"
TO FIND CONTACT WIPE
LIFT TO CLS BRKR NOW
```

Fully close the breaker. When the breaker is at the close position (on latch), press the **[ENTER]** key to find contact wipe.

- e. The test results will be printed, and you will be returned to the "START-UP" menu. A typical "Slow-Close" test results printout is shown in Figure 15.



**NOTES**

- The "Slow-Close" test report can be saved in the DigiTMR S2's EEPROM. Please see section 3.10.1 for information on how to save test records.
- You can calculate contact stroke by adding the contact touch and contact wipe distances.

BREAKER TIMING RESULTS - 60 Hz		
SHOT NUMBER: 1		
DATE: 07/10/12      TIME: 12:34:37		
COMPANY:		
STATION:		
CIRCUIT:		
MFR:		
MODEL:		
S/N:		
OPERATOR:		
TEST: SLOW CLOSE		
	CT TOUCH	CT WIPE
CH 1	1.07 in	0.34 in
CH 2	1.25 in	0.16 in
CH 3	1.24 in	0.17 in

Figure 15. Typical "Slow-Close" Test Results Printout

<http://www.51082245.com>

### 3.8.2. Performing a Transducer Self-Test

The transducer electronics can be checked by connecting the transducer to the DigiTMR S2 and running a “Test Transducer” diagnostic test. To test the transducer:

- a. Start from the “START-UP” menu:

```
1. TIME BREAKER
2. GET RESULTS
3. SETUP
4. DIAGNOSTICS
```

Press the **[4]** key (*DIAGNOSTICS*).

- b. The following screen will be displayed:

```
1. SLOW CLOSE TEST
2. CHECK HOOKUP
3. TEST TRANSDUCER
4. PRINT DATA
5. ENCODER FILTER
6. CONTACT FILTER
```

Press the **[3]** key (*TEST TRANSDUCER*).

- c. The following screen will be displayed:

```
TRANSDUCER TEST:

1=000.00 IN / 000.0°
```

Move the transducer slider and observe the DigiTMR S2's display. The transducer's movement will be displayed in inches and degrees. If the transducer slider is moved 1.00 inch, the DigiTMR should display 1.00 inch.

Press the **[STOP]** key to end the test and return to the “START-UP” menu.

### 3.8.3. Checking Cable Hookups

To check the cable hookups:

- a. Start from the "START-UP" menu:

```
1. TIME BREAKER
2. GET RESULTS
3. SETUP
4. DIAGNOSTICS
```

Press the **[4]** key (*DIAGNOSTICS*).

- b. The following screen will be displayed:

```
1. SLOW CLOSE TEST
2. CHECK HOOKUP
3. TEST TRANSDUCER
4. PRINT DATA
5. ENCODER FILTER
6. CONTACT FILTER
```

Press the **[2]** key (*CHECK HOOKUP*).

- c. The following screen will be displayed:

```
MAKE SURE BREAKER IS
IN CLOSED POSITION

THEN PRESS "START"
```

Confirm that the breaker is in closed position and then press the **[START]** key.

- d. The test results will be displayed on the screen as shown below and also printed on the thermal printer:

```
1   2   3
C   -   -
```

**NOTE**

A contact closure is shown as "C" on the screen and on the printout. An open contact is shown as "-" on the screen and on the printout.

<http://www.51082245.com>

### 3.9 Printing Test Results

After a timing test has been performed, the test results can be printed in graphical or tabulated format on the DigiTMR S2's built-in thermal printer.

#### 3.9.1. Printing the Tabulated Test Results

To print the tabulated test results from the last test performed:

- a. Start from the "START-UP" menu:

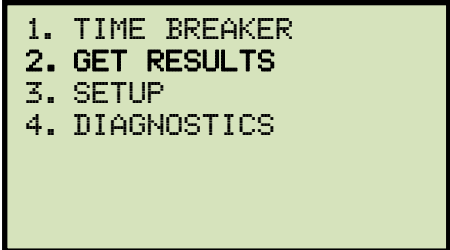

```
1. TIME BREAKER
2. GET RESULTS
3. SETUP
4. DIAGNOSTICS
```

Press the **[2]** key (*GET RESULTS*) to get the last test results.

- b. The following screen will be displayed:

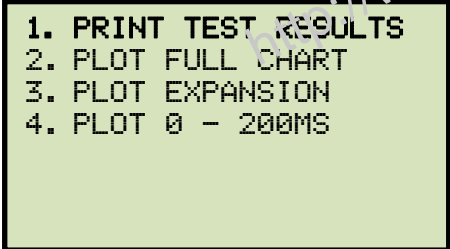

```
1. PRINT TEST RESULTS
2. PLOT FULL CHART
3. PLOT EXPANSION
4. PLOT 0 - 200MS
```

Press the **[1]** key (*PRINT TEST RESULTS*).

- c. The following screen will be displayed:



```
SELECT PRINTER

1. THERMAL PRINTER
2. DISPLAY RESULTS
```

Press the **[1]** key (*THERMAL PRINTER*).

- d. The following screen will be displayed while the results are being printed:



A typical tabulated test results printout for an OPEN operation is shown in Figure 16. When the printer is done printing, you will be returned to the "START-UP" menu.

<http://www.51082245.com>

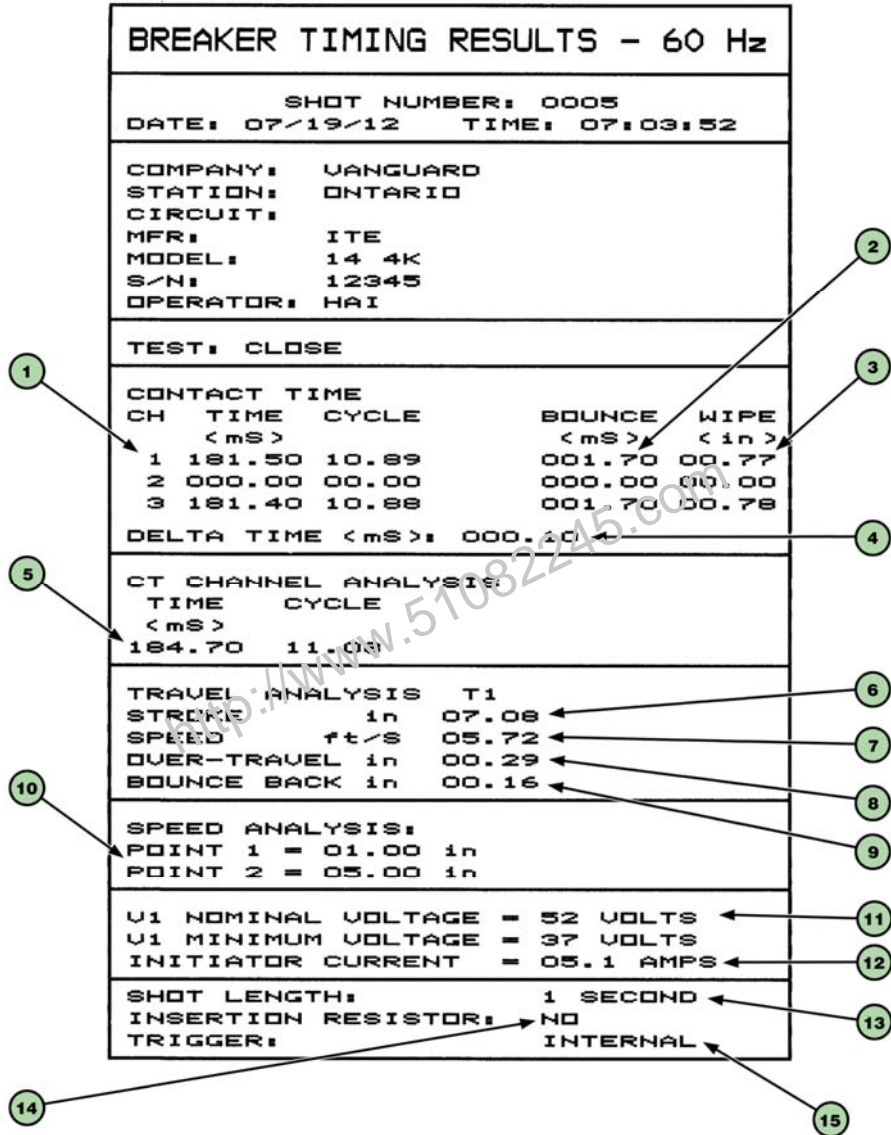

Figure 16. Typical Tabulated Test Results Printout of an OPEN Operation



Table 2. Descriptions of Tabulated Test Results Elements

Item Number	Description
1	Contact time shown in both milliseconds and cycles. In the sample report shown in Figure 16, contact channel #1 time is 181.50 ms or 10.89 cycles.
2	Contact bounce duration (1.70 ms).
3	Contact wipe (0.77 inches).
4	Delta time - the slowest contact and fastest contact differential time (0.10 ms).
5	The AC current sensor time is shown as "CT Channel Analysis" time in milliseconds and cycles. The CT time in the example shown is 184.70 ms or 11.080 cycles. Since the report was generated to show both Quick-Shot Mode and Travel-Time Mode data, both CT time and contact-travel readings are shown on the report.
6	Breaker contact stroke (7.08 inches).
7	Contact velocity calculation (5.72 feet per second).
8	Contact over-travel distance (0.29 inches).
9	Contact bounce-back distance (0.16 inches).
10	Contact velocity calculation taken from two analysis points: Analysis point #1 is 1.00 inch from the fully closed position. Analysis point #2 is 5.00 inches from the fully closed position.
11	The DC power supply was monitored during the test. The nominal voltage was 52V and the minimum voltage was 37V.
12	Initiate current (5.1 Amperes)
13	Timing shot duration (1 second)
14	Insertion resistor time was not measured since there was no insertion resistor in this test.
15	Trigger mode was internal therefore the timing window started at the same time when the DigiTMR energized the circuit breaker closing coil circuit.

### 3.9.2. Printing the Graphic Test Results

To print the graphic test results from the last test performed:

- a. Start from the "START-UP" menu:

```
1. TIME BREAKER
2. GET RESULTS
3. SETUP
4. DIAGNOSTICS
```

Press the **[2]** key (*GET RESULTS*) to get the last test results.

- b. The following screen will be displayed:

```
1. PRINT TEST RESULTS
2. PLOT FULL CHART
3. PLOT EXPANSION
4. PLOT 0 - 200MS
```

Press the **[2]** key (*PLOT FULL CHART*).



#### NOTES

#### Option details

- **PRINT TEST RESULTS**  
Prints the tabulated test results.
- **PLOT FULL CHART**  
Graphically plots the entire test results. See Figure 17 for an example.
- **PLOT EXPANSION**  
Can expand the graphic results in 100 millisecond increments. See Figure 18 for an example.
- **PLOT 0 – 200MS**  
Automatically plots the timing chart from 0 to 200 milliseconds in the expansion mode with 10 ms timing markers. An example is shown in Figure 18.

Graphic result interpretations are shown in Figures Figure 19, Figure 20, and Figure 21.

- c. The following screen will be displayed while the graph is being printed:

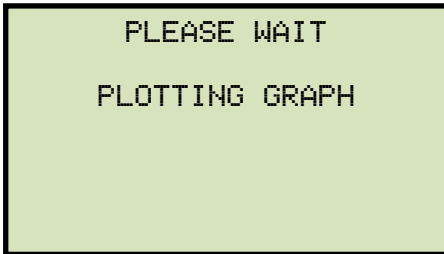

Figure 17 shows a CLOSE timing chart of a circuit breaker with contact activity on channels 1 and 3. A CT channel is also shown on the chart. Since the printout was generated to show both Quick-Shot Mode and Time-Travel Mode, both the CT time and Contact-Travel readings are shown on the chart.

**NOTES**

- If the results are from a test using the 1 second window, the graph will be from 0 to 1000 ms with 50 ms time markers.
- If the results are from a test using the 10 second window, the graph will be from 0 to 10 sec with 500 ms time markers.
- If the results are from a test using the 20 second window, the graph will be from 0 to 20 sec with 1 second time markers.

- d. When the printer is done printing the graphic test results, you will be returned to the "START-UP" menu.

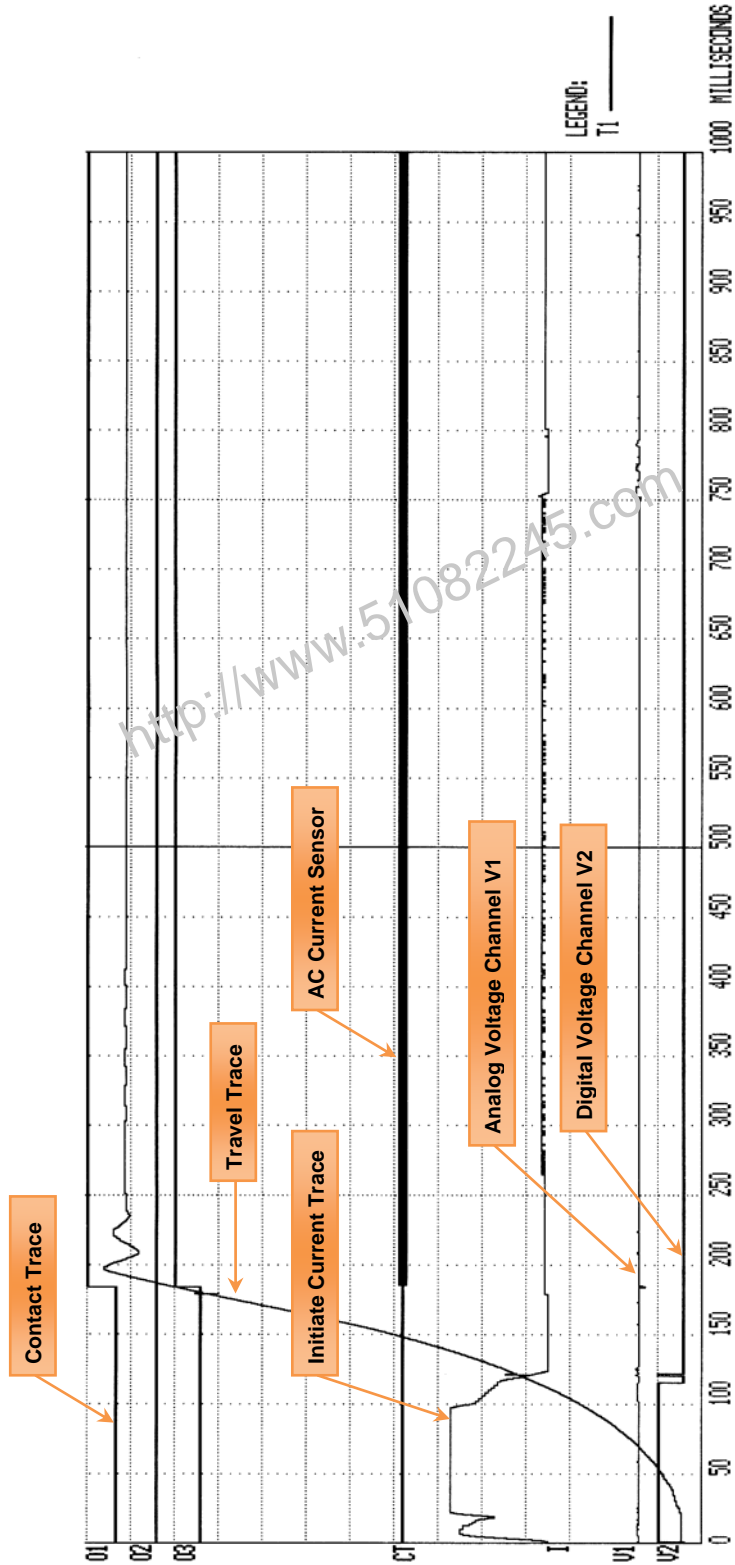

Figure 17. Typical Graphic Test Results Printout

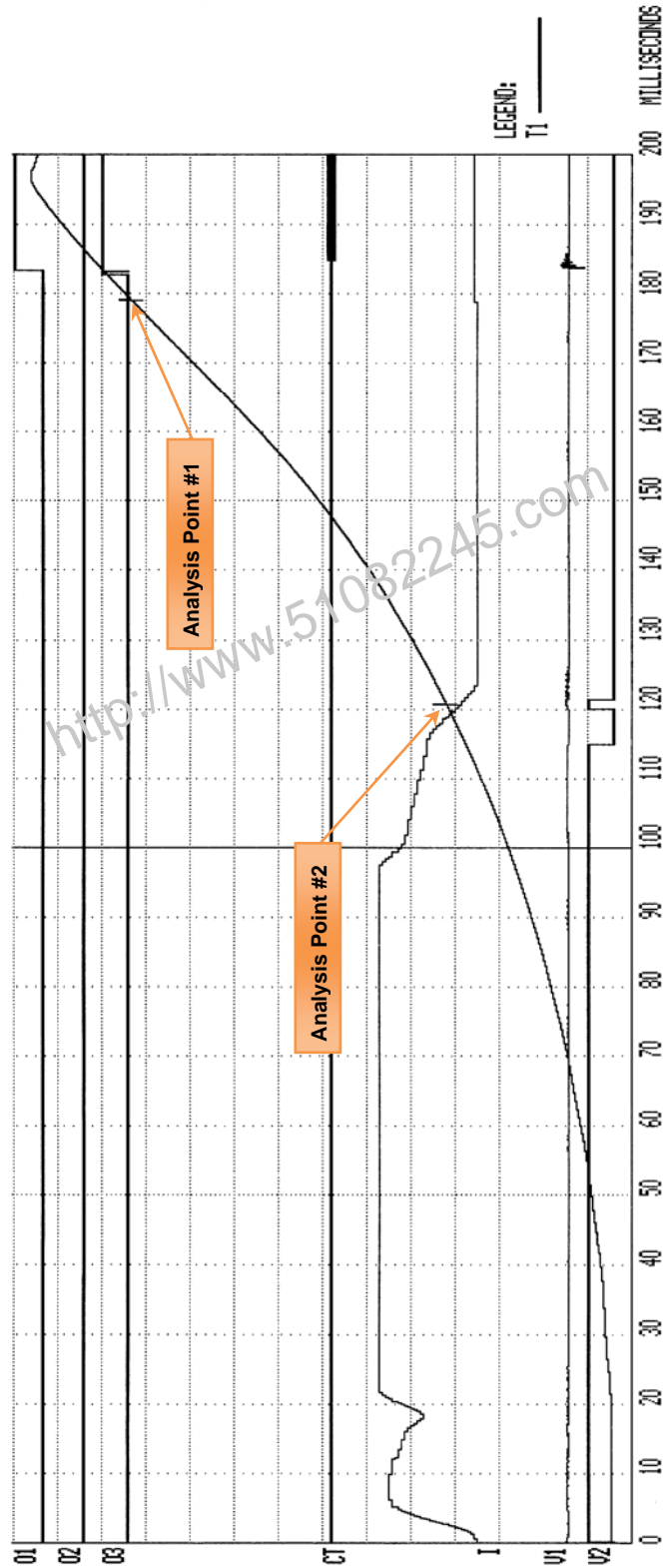

Figure 18. Expansion Graph from 0 to 200 ms

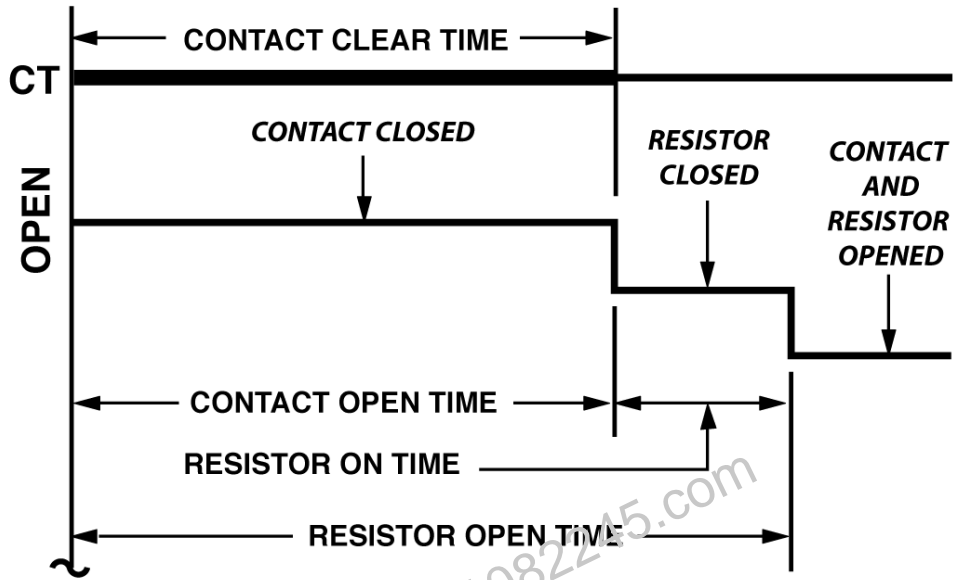

Figure 19. Graphic Interpretation of an OPEN Timing Shot

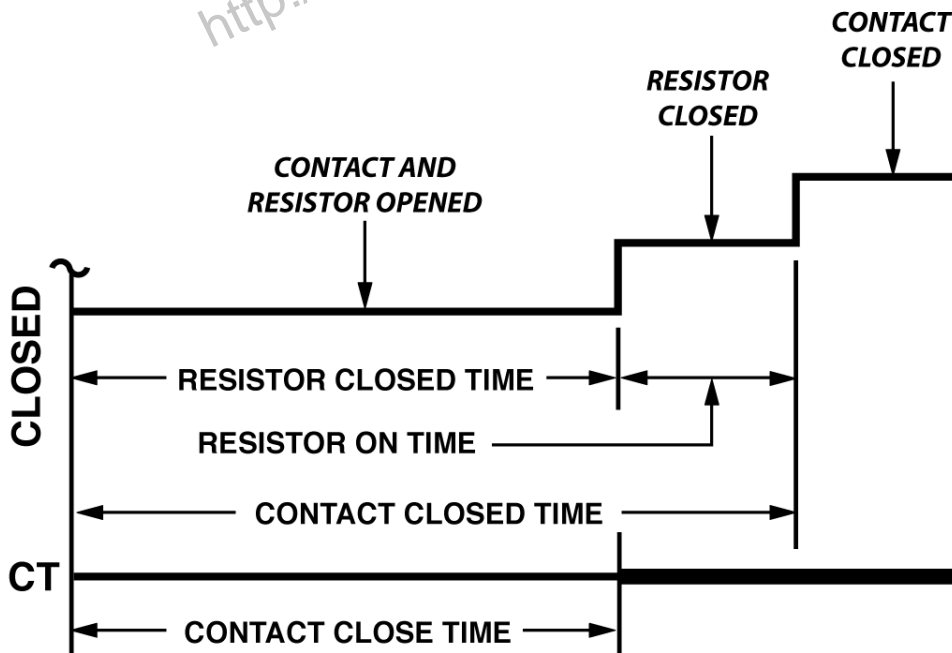

Figure 20. Graphic Interpretation of a CLOSE Timing Shot

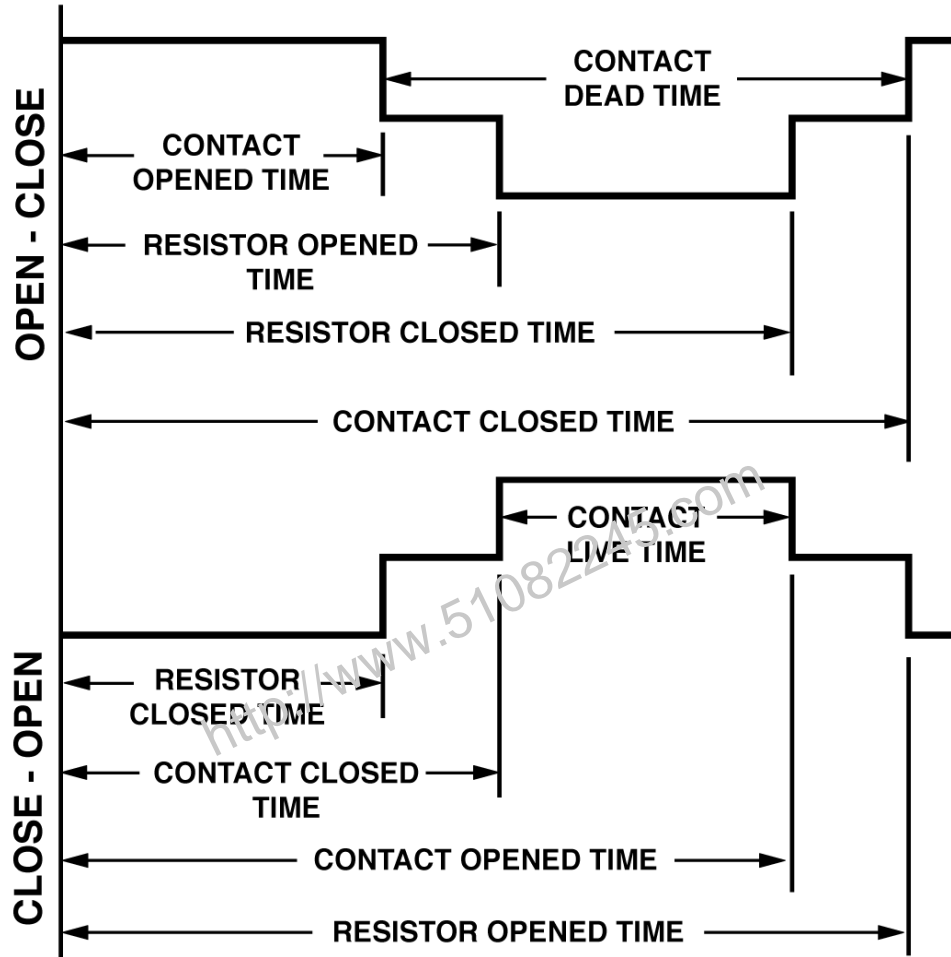

Figure 21. Graphic Interpretations of OPEN-CLOSE and CLOSE-OPEN Timing Shots

## 3.10 Working with Timing Shots

### 3.10.1. Saving Timing Shots

After performing a test, the test shot can be saved in the DigiTMR's EEPROM or to a connected USB Flash drive by using the steps below:

- a. Start from the "START-UP" menu:

```
1. TIME BREAKER
2. GET RESULTS
3. SETUP
4. DIAGNOSTICS
```

Press the **[3]** key (*SETUP*).

- b. The following screen will be displayed:

```
1. ANALYSIS POINTS
2. MEASUREMENT UNITS
3. SAVE / RESTORE
4. SHOT DESCRIPTION
5. NEXT PAGE
```

Press the **[3]** key (*SAVE / RESTORE*).

- c. The following screen will be displayed:

```
1. SAVE SHOT
2. RESTORE SHOT
3. SHOT DIRECTORY
4. ERASE SHOT
5. COPY TO THUMB DRIVE
```



Option 5 (*COPY TO THUMB DRIVE*) will be listed only if a USB Flash drive is connected to the DigiTMR S2.

**NOTE**

Press the **[1]** key (*SAVE SHOT*).



- d. The following screen will be displayed:

```
SAVE SHOT # 3
TEST: OPEN
DATE: 07/12/12 13:25

"ENTER" TO PROCEED
```

Press the **[ENTER]** key to continue.

**If a USB Flash drive is connected to the unit, continue to step e.**

**If a USB Flash drive is NOT connected to the unit, continue to step f.**

- e. The following screen will be displayed:

```
1. SAVE INTERNALLY
2. SAVE TO THUMB DRIVE
```

1. *SAVE INTERNALLY*

Press the **[1]** key (*SAVE INTERNALLY*) to save the test record to the unit's Flash EEPROM. **Continue to step f.**

2. *SAVE TO THUMB DRIVE*

Press the **[2]** key (*SAVE TO THUMB DRIVE*) to save the test record to the connected USB Flash drive. The following screen will be displayed while the test shot is being saved:

```
SAVE IN PROGRESS
PLEASE WAIT
```

The following screen will be displayed when the shot has been saved:

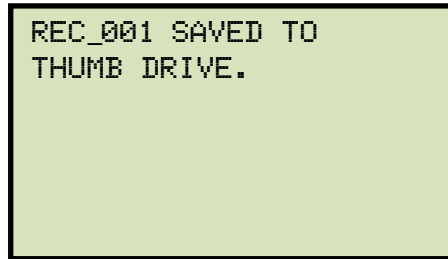

```
REC_001 SAVED TO  
THUMB DRIVE.
```

Press any key to return to the "START-UP" menu.

- f. The following screen will be displayed while the test shot is being saved:



```
SAVE IN PROGRESS  
PLEASE WAIT
```

The following screen will be displayed when the shot has been saved:



```
SHOT SAVED
```

Press the **[ENTER]** key. You will be returned to the "START-UP" menu.

### 3.10.2. Printing a Timing Shot Directory

A listing of all the shots stored in the DigiTMR S2's EEPROM or on a connected Flash drive can be printed on the built-in thermal printer using the steps below:

- a. Start from the "START-UP" menu:

```
1. TIME BREAKER
2. GET RESULTS
3. SETUP
4. DIAGNOSTICS
```

Press the **[3]** key (*SETUP*).

- b. The following screen will be displayed:

```
1. ANALYSIS POINTS
2. MEASUREMENT UNITS
3. SAVE / RESTORE
4. SHOT DESCRIPTION
5. NEXT PAGE
```

Press the **[3]** key (*SAVE / RESTORE*).

- c. The following screen will be displayed:

```
1. SAVE SHOT
2. RESTORE SHOT
3. SHOT DIRECTORY
4. ERASE SHOT
5. COPY TO THUMB DRIVE
```

Press the **[3]** key (*SHOT DIRECTORY*).

**If a USB Flash drive is connected to the unit, continue to step d.**

**If a USB Flash drive is NOT connected to the unit, continue to step e.**

- d. The following screen will be displayed:

```
1. INTERNAL DIRECTORY
2. THUMB DRIVE DIR
```

1. *INTERNAL DIRECTORY*

Press the **[1]** key (*INTERNAL DIRECTORY*) to print a directory of test shots stored in the unit's EEPROM. **Continue to step e.**

2. *THUMB DRIVE DIR*

Press the **[2]** key (*THUMB DRIVE DIR*) to print a directory of test shots stored on a connected USB Flash drive. The directory will be printed on the unit's built-in thermal printer and you will be returned to the "START-UP" menu. A typical thumb drive directory printout is shown in Figure 22.

e. The following screen will be displayed:

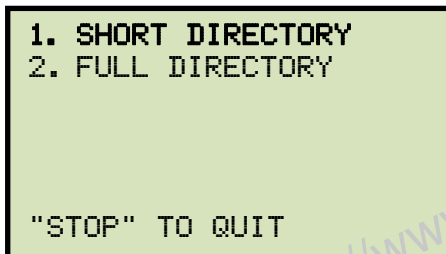

Press the **[1]** key (*SHORT DIRECTORY*).



**NOTES**

- If the *SHORT DIRECTORY* option is selected, the DigiTMR S2 will print the shot numbers and header information of the last ten timing shots stored in the EEPROM.
- If the *FULL DIRECTORY* option is selected, the DigiTMR S2 will print the shot numbers and header information of all timing shots stored in the EEPROM.
- A typical shot directory printout is shown in Figure 23.

f. The following screen will be displayed while the directory is being printed:

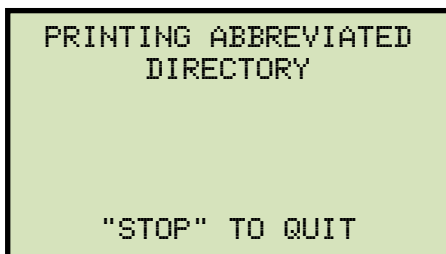

When printing has finished, you will be returned to the "START-UP" menu.

THUMB DRV DIR	
THUMB DRV FILENAME: REC_002	DATE/TIME: 07/12/12 13:25:06
COMPANY:	MFR:
STATION:	MODEL:
CIRCUIT:	OPERATOR:
TEST: OPEN	
THUMB DRV FILENAME: REC_001	DATE/TIME: 07/12/12 13:25:06
COMPANY:	MFR:
STATION:	MODEL:
CIRCUIT:	OPERATOR:
TEST: OPEN	
THUMB DRV FILENAME: REC_000	DATE/TIME: 07/12/12 13:25:06
COMPANY:	MFR:
STATION:	MODEL:
CIRCUIT:	OPERATOR:
TEST: OPEN	
THUMB DRV FILENAME: REC_003	DATE/TIME: 07/09/12 08:18:59
COMPANY:	MFR:
STATION:	MODEL:
CIRCUIT:	OPERATOR:
TEST: OPEN	
THUMB DRV FILENAME: REC_004	DATE/TIME: 05/18/12 10:10:10
COMPANY:	MFR:
STATION:	MODEL:
CIRCUIT:	OPERATOR:
TEST: OPEN-CLOSE-OPEN	

Figure 22. Typical Thumb Drive Shot Directory Printout

TIMING SHOT ABBREVIATED DIRECTORY			
SHOT NUMBER: 0004			
DATE : 07/12/12	TIME : 08:08:42	COMPANY :	MFR :
STATION :	MODEL :	CIRCUIT :	SERIAL :
OPERATOR:	TEST : OPEN		
SHOT NUMBER: 0003			
DATE : 07/12/12	TIME : 08:07:03	COMPANY :	MFR :
STATION :	MODEL :	CIRCUIT :	SERIAL :
OPERATOR:	TEST : CLOSE		
SHOT NUMBER: 0002			
DATE : 07/12/12	TIME : 07:57:42	COMPANY :	MFR :
STATION :	MODEL :	CIRCUIT :	SERIAL :
OPERATOR:	TEST : OPEN		
SHOT NUMBER: 0005			
DATE : 07/12/12	TIME : 07:56:10	COMPANY : VANGUARD INSTRUMENT	MFR : ITE
STATION :	MODEL : 12345	CIRCUIT : 14 4	SERIAL :
OPERATOR: HAI	TEST : CLOSE		

Figure 23. Typical Internal Shot Directory Printout

### 3.10.3. Restoring a Test Shot

Use the steps below to restore a test record from the DigiTMR S2's internal Flash EEPROM or a connected USB Flash drive to the working memory:

- a. Start from the "START-UP" menu:

```
1. TIME BREAKER
2. GET RESULTS
3. SETUP
4. DIAGNOSTICS
```

Press the **[3]** key (*SETUP*).

- b. The following screen will be displayed:

```
1. ANALYSIS POINTS
2. MEASUREMENT UNITS
3. SAVE / RESTORE
4. SHOT DESCRIPTION
5. NEXT PAGE
```

Press the **[3]** key (*SAVE / RESTORE*).

- c. The following screen will be displayed:

```
1. SAVE SHOT
2. RESTORE SHOT
3. SHOT DIRECTORY
4. ERASE SHOT
5. COPY TO THUMB DRIVE
```



Option 5 (*COPY TO THUMB DRIVE*) will be listed only if a USB Flash drive is connected to the unit.

**NOTE**

Press the **[2]** key (*RESTORE SHOT*).

**If a USB flash drive is connected, continue to step d.**

**If a USB flash drive is NOT connected, continue to step e.**

d. The following screen will be displayed:

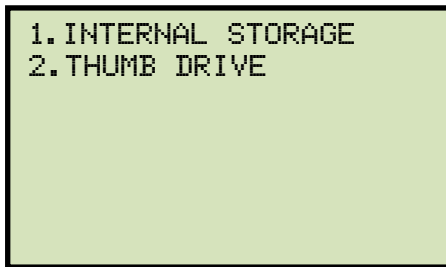

1. *INTERNAL STORAGE*

Press the **[1]** key (*INTERNAL STORAGE*) to restore a test shot from the unit's internal Flash EEPROM. **Continue to step e.**

2. *THUMB DRIVE*

Press the **[2]** key (*THUMB DRIVE*) to restore a test shot from a connected USB Flash drive. The following screen will be displayed:

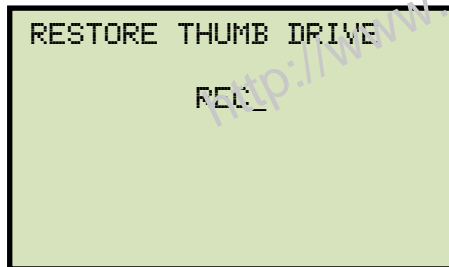

Type the record number using the keypad and then press the **[ENTER]** key. If you do not know the record number, you can first print a test shot directory (see section 3.10.2). After the test shot has been restored to the working memory, the following screen will be displayed:

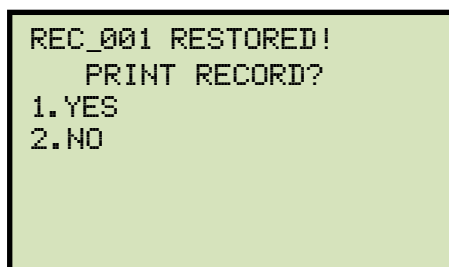

Press the **[1]** key (*YES*) if you would like to print the restored test record. The test record will be printed and you will be returned to the "START-UP" menu. The restored record will remain in the working memory.

Press the **[2]** key (*NO*) if you do not want to print the test record. You will be returned to the "START-UP" menu. The restored record will remain in the working memory.

- e. The following screen will be displayed:

```
ENTER SHOT NUMBER  
TO BE RESTORED  
-  
"ENTER" TO CONFIRM
```

Using the numeric keypad, type the shot number that you would like to recall, and then press the **[ENTER]** key. If you do not know the record number, you can first print a test shot directory (see section 3.10.2).

- f. The following screen will be displayed:

```
RESTORING SHOT #1  
TEST: 0 - C - 0  
DATE: 07/12/12 10:10  
"ENTER" TO CONFIRM
```

Press the **[ENTER]** key. Once the record has been restored, the following screen will be displayed:

```
RESTORE COMPLETE
```

Press any key to continue. You will be returned to the "START-UP" menu.



### 3.10.4. Erasing Timing Shots

Use the steps below to erase (delete) timing shots from the DigiTMR's EEPROM or from a connected USB Flash drive:

- a. Start from the "START-UP" menu:

```
1. TIME BREAKER
2. GET RESULTS
3. SETUP
4. DIAGNOSTICS
```

Press the **[3]** key (*SETUP*).

- b. The following screen will be displayed:

```
1. ANALYSIS POINTS
2. MEASUREMENT UNITS
3. SAVE / RESTORE
4. SHOT DESCRIPTION
5. NEXT PAGE
```

Press the **[3]** key (*SAVE / RESTORE*).

- c. The following screen will be displayed:

```
1. SAVE SHOT
2. RESTORE SHOT
3. SHOT DIRECTORY
4. ERASE SHOT
5. COPY TO THUMB DRIVE
```



Option 5 (*COPY TO THUMB DRIVE*) will be listed only if a USB Flash drive is connected to the unit.

**NOTE**

Press the **[4]** key (*ERASE SHOT*).

**If a USB Flash drive is connected, continue to step d.**

**If a USB Flash drive is NOT connected, continue to step e.**

d. The following screen will be displayed:

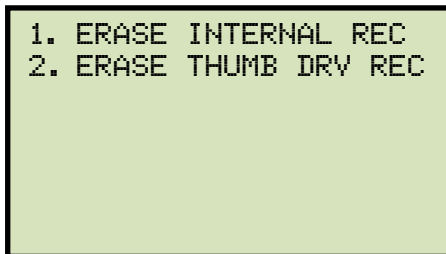

```
1. ERASE INTERNAL REC
2. ERASE THUMB DRV REC
```

1. *ERASE INTERNAL REC*

Press the **[1]** key (*ERASE INTERNAL REC*) if you would like to erase test records that are stored in the unit's internal Flash EEPROM. **Continue to step e.**

2. *ERASE THUMB DRV REC*

Press the **[2]** key (*ERASE THUMB DRV REC*) if you would like to erase test records that are stored on a connected USB Flash drive. The following screen will be displayed:

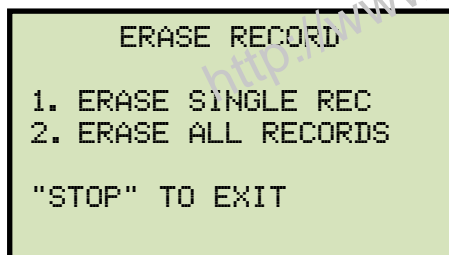

```
ERASE RECORD
1. ERASE SINGLE REC
2. ERASE ALL RECORDS
"STOP" TO EXIT
```

1. *ERASE SINGLE REC*

Press the **[1]** key (*ERASE SINGLE REC*) to erase a single record from the USB Flash drive. The following screen will be displayed:

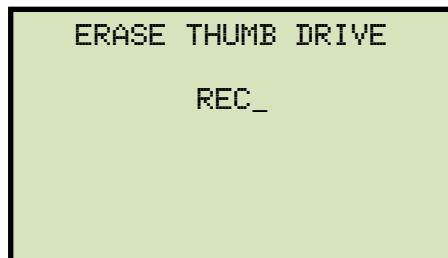

```
ERASE THUMB DRIVE
REC_
```

Type the record number that you would like to erase and then press the **[ENTER]** key. If you do not know the record number, you can first print a record directory (please see section 3.10.2). The selected record will be erased and the following screen will be displayed:

```
THUMB DRIVE REC_001
ERASED!
```

Press any key to continue. The following screen will be displayed allowing you to continue deleting additional records:

```
ERASE RECORD

1. ERASE SINGLE REC
2. ERASE ALL RECORDS

"STOP" TO EXIT
```

Follow the steps above to erase additional records or press the **[STOP]** key to return to the "START-UP" menu.

## 2. ERASE ALL RECORDS

Press the **[2]** key (*ERASE ALL RECORDS*) to erase all records from the USB Flash drive. The following screen will be displayed:

```
ERASE ALL THUMB DRIVE
RECORDS!

ARE YOU SURE?

"ENTER" TO CONTINUE
```



You can press the **[STOP]** key if you do not want to delete any records. You will be returned to the "START-UP" menu.

### NOTE

Press the **[ENTER]** key if you would like to erase ALL the test records stored on the connected USB Flash drive. All records will be erased and the following screen will be displayed:

```
ALL THUMB DRIVE
RECORDS ERASED!
```

Press any key to return to the "START-UP" menu.

e. The following screen will be displayed:

```
1. ERASE SINGLE SHOT
2. ERASE ALL SHOTS!
```

1. *ERASE SINGLE SHOT*

Press the **[1]** key (*ERASE SINGLE SHOT*) to erase a single test shot from the unit's Flash EEPROM. The following screen will be displayed:

```
ENTER SHOT NUMBER
  TO BE ERASED

-

"ENTER" TO CONFIRM
```

Type the record number that you would like to erase and then press the [ENTER] key. If you do not know the record number, you can first print a record directory (please see section 3.10.2). The following confirmation screen will be displayed:

```
ERASE SHOT # 2
TEST: OPEN
DATE: 07/09/12 08:18

"ENTER" TO CONFIRM
```

Press the **[ENTER]** key to confirm the deletion of the selected record (you can press the **[STOP]** key to cancel the process). The test record will be erased and the following screen will be displayed:



Press any key to return to the "START-UP" menu.

## 2. ERASE ALL SHOTS!

Press the **[2]** key (*ERASE ALL SHOTS!*) to erase all test shots from the unit's Flash EEPROM. The following screen will be displayed:

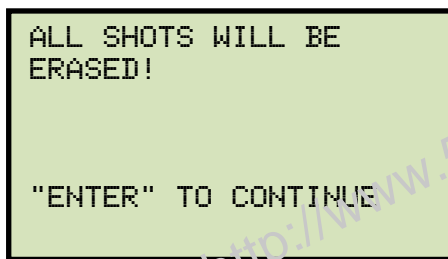

Press the **[ENTER]** key to continue (you can press the **[STOP]** key to cancel). A progress screen will be displayed while the records are being erased. Once all records have been erased from the unit's Flash EEPROM, the following screen will be displayed:

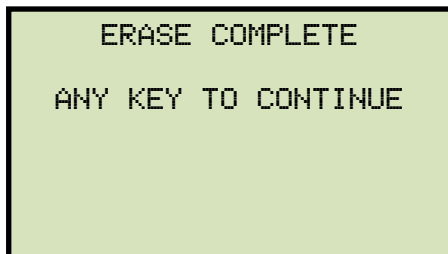

Press any key to return to the "START-UP" menu.

### 3.10.5. Copying Test Shots to a USB Flash Drive

Use the steps below to copy one or all test records from the unit's Flash EEPROM to a connected USB Flash drive:

- a. Make sure a USB Flash drive is connected to the unit's "USB MEM" port, and then start from the "START-UP" menu:

```
1. TIME BREAKER
2. GET RESULTS
3. SETUP
4. DIAGNOSTICS
```

Press the **[3]** key (*SETUP*).

- b. The following screen will be displayed:

```
1. ANALYSIS POINTS
2. MEASUREMENT UNITS
3. SAVE / RESTORE
4. SHOT DESCRIPTION
5. NEXT PAGE
```

Press the **[3]** key (*SAVE / RESTORE*).

- c. The following screen will be displayed:

```
1. SAVE SHOT
2. RESTORE SHOT
3. SHOT DIRECTORY
4. ERASE SHOT
5. COPY TO THUMB DRIVE
```

Press the **[5]** key (*COPY TO THUMB DRIVE*).

- d. The following screen will be displayed:

```
COPY REC TO THUMB DRV

1. COPY SINGLE RECORD
2. COPY ALL RECORDS
```

### 1. COPY SINGLE RECORD

Press the **[1]** key (*COPY SINGLE RECORD*) to copy a single test record from the unit's Flash EEPROM to the connected USB Flash drive. The following screen will be displayed:

```
ENTER RECORD NUMBER  
TO COPY TO FLASH DRV  
  
NUMBER:
```

Type the record number using the keypad and then press the **[ENTER]** key. The selected test record will be copied to the USB Flash drive and the following screen will be displayed:

```
REC_001 SAVED TO  
THUMB DRIVE.
```

Press any key to return to the "START-UP" menu.

### 2. COPY ALL RECORDS

Press the **[2]** key (*COPY ALL RECORDS*) to copy all test records from the unit's Flash EEPROM to the connected USB Flash drive. All test records will be copied and the following screen will be displayed when the process is finished:

```
ALL RECORDS HAVE BEEN  
TRANSFERRED TO THUMB  
DRIVE!
```

Press any key to return to the "START-UP" menu.

### 3.11 Working with Breaker Test Plans

A breaker test plan is comprised of all circuit-breaker performance specifications (stroke, velocity, and contact time). Following is a typical list of operating parameters contained in a test plan:

- Maximum and minimum Contact Trip Time
- Maximum and minimum Contact Close Time
- Maximum Contact Spread Time
- Maximum and minimum Resistor On Time
- Maximum and minimum Stroke
- Maximum and minimum Trip/Close Velocity
- Maximum and minimum Over Travel (Open/Close)
- Maximum and minimum Bounce Back (Open/Close)
- Trip Analysis Points
- Close Analysis Points

Circuit breaker test plans can be created on a PC using the included VCBA S2 software (please see the VCBA S2 Software Manual for further information). Test plans can then be transferred from the PC to the DigiTMR S2 via the USB interface. The DigiTMR S2 can store up to 100 circuit breaker test plans in its Flash EEPROM.

By recalling a test plan before testing, the user does not have to set analysis points to calculate the Trip or Close velocity of the circuit breaker contacts. Since the test plan contains the breaker test parameters, the test report will also display the “Pass” or “Fail” status for each parameter tested based on comparing the test results with the parameters in the test plan. A typical test report with “Pass” or “Fail” indicators is shown in Appendix D.



### 3.11.1. Recalling a Breaker Test Plan

You can recall a test plan to the working memory by using the steps below:

- a. Start from the "START-UP" menu:

```
1. TIME BREAKER
2. GET RESULTS
3. SETUP
4. DIAGNOSTICS
```

Press the **[3]** key (*SETUP*).

- b. The following screen will be displayed:

```
1. ANALYSIS POINTS
2. MEASUREMENT UNITS
3. SAVE / RESTORE
4. SHOT DESCRIPTION
5. NEXT PAGE
```

Press the **[1]** key (*ANALYSIS POINTS*).

- c. The following screen will be displayed:

```
1. OPEN TIMING
2. CLOSE TIMING
3. PRINT SETTINGS
4. TEST PLANS
```

Press the **[4]** key (*TEST PLANS*).

- d. The following screen will be displayed:

```
1. LOAD TEST PLAN
2. PRINT TEST PLAN
3. PRINT DIRECTORY
```

Press the **[1]** key (*LOAD TEST PLAN*).

- e. The following screen will be displayed showing the details of the first test plan stored in the unit:

```
TEST PLAN #: 01
145PMI 40-20
ABB

"UP" OR "DOWN"
TO SCROLL...
"ENTER" TO SELECT
```



If there are no test plans stored in the DigiTMR S2, the following screen will be displayed:

NOTE

```
NO TEST PLANS FOUND

"ENTER" TO CONTINUE
```

Press the **[ENTER]** key to return to the "START-UP" menu.

- You can scroll through all the test plans stored in the unit by pressing the **[^]** or **[v]** key. Press the **[ENTER]** key when you have found the test plan that you would like to use.
- f. The test plan will be loaded in the working memory, and you will be returned to the "START-UP" menu. The loaded test plan will be used for all subsequent tests performed.

### 3.11.2. Printing a Breaker Test Plan

To print a breaker test plan:

- a. Start from the "START-UP" menu:

```
1. TIME BREAKER
2. GET RESULTS
3. SETUP
4. DIAGNOSTICS
```

Press the **[3]** key (*SETUP*).

- b. The following screen will be displayed:

```
1. ANALYSIS POINTS
2. MEASUREMENT UNITS
3. SAVE / RESTORE
4. SHOT DESCRIPTION
5. NEXT PAGE
```

Press the **[1]** key (*ANALYSIS POINTS*).

- c. The following screen will be displayed:

```
1. OPEN TIMING
2. CLOSE TIMING
3. PRINT SETTINGS
4. TEST PLANS
```

Press the **[4]** key (*TEST PLANS*).

- d. The following screen will be displayed:

```
1. LOAD TEST PLAN
2. PRINT TEST PLAN
3. PRINT DIRECTORY
```

Press the **[2]** key (*PRINT TEST PLAN*).

- e. The following screen will be displayed listing the first test plan:

```

TEST PLAN #: 01
145PMI 40-20
ABB

"UP" OR "DOWN"
TO SCROLL...
"ENTER" TO SELECT

```

Press the **[↑]** or **[↓]** key to scroll through the list of stored test plans. Press the **[ENTER]** key when you have found the test plan that you would like to print.

- f. The selected test plan will be printed and you will be returned to the "START-UP" menu. A typical test plan printout is shown in Figure 24.

TEST PLAN NUMBER 1				
MFR:	ABB			
TYPE:	145PMI 40-20			
COMMENT:				
CONTACT TIME PARAMETERS				
		OPEN	CLOSE	
MAX <ms>		30.0	65.0	
MIN <ms>		23.0	40.0	
DELTA LIM <ms>		3.0	4.0	
C-D, D-C PARAMS: LIVE DEAD				
MAX <ms>		38.0	350.0	
MIN <ms>		20.0	333.3	
RESISTOR ON-TIME PARAMETERS				
		OPEN	CLOSE	
MAX <ms>		0.0	0.0	
MIN <ms>		0.0	0.0	
DELTA LIM <ms>		0.0	0.0	
C-D, D-C PARAMS: LIVE DEAD				
MAX <ms>		0.0	0.0	
MIN <ms>		0.0	0.0	
TRAVEL PARAMETERS				
	STRK	VEL	D-TUL	BNC-BK
	mm	M/S	mm	mm
OPEN HI	108.5	5.10	5.1	5.1
OPEN LOW	105.4	5.00	0.0	0.0
CLOSE HI	108.5	4.00	5.1	5.1
CLOSE LD	105.4	3.90	0.0	0.0
ROTARY ENC: 0.00 MM/DEGREE				
OPEN SPEED ANALYSIS POINTS:				
POINT 1 = 37.1 mm				
POINT 2 = 67.1 mm				
CLOSE SPEED ANALYSIS POINTS:				
POINT 1 = 37.1 mm				
POINT 2 = 67.1 mm				

Figure 24. Typical Test Plan Printout

### 3.11.3. Printing the Breaker Test Plan Directory

Follow the steps below to print a directory of all the test plans stored in the DigiTMR S2's EEPROM:

- a. Start from the "START-UP" menu:

```
1. TIME BREAKER
2. GET RESULTS
3. SETUP
4. DIAGNOSTICS
```

Press the **[3]** key (*SETUP*).

- b. The following screen will be displayed:

```
1. ANALYSIS POINTS
2. MEASUREMENT UNITS
3. SAVE / RESTORE
4. SHOT DESCRIPTION
5. NEXT PAGE
```

Press the **[1]** key (*ANALYSIS POINTS*).

- c. The following screen will be displayed:

```
1. OPEN TIMING
2. CLOSE TIMING
3. PRINT SETTINGS
4. TEST PLANS
```

Press the **[4]** key (*TEST PLANS*).

- d. The following screen will be displayed:

```
1. LOAD TEST PLAN
2. PRINT TEST PLAN
3. PRINT DIRECTORY
```

Press the **[3]** key (*PRINT DIRECTORY*).

- e. The test plan directory will be printed, and you will be returned to the "START-UP" menu. A sample test plan printout is shown in Figure 25.

TEST PLAN DIRECTORY	
TEST PLAN #:	1
BRKR TYPE:	14.4KS500-20B
BRKR MFR:	ITE
COMMENTS:	
TEST PLAN #:	2
BRKR TYPE:	SP-72.5-23-2
BRKR MFR:	SIEMENS
COMMENTS:	

Figure 25. Typical Test Plan Directory Printout

<http://www.51082245.com>

### 3.12 Setting Up Analysis Points

Analysis points are used to calculate the average contact velocity through the contact's arc zone. The analysis points are usually specified by the breaker's manufacturer. The user can enter the analysis points, and the DigiTMR S2 will store the two setup points for calculating velocity, one set each for the open and close operations.



#### NOTES

- Average velocity through the arc zone is calculated by using the formula below:  

$$V_{ave} = \text{Distance} / \text{Time}$$
- The breaker contact velocity is calculated based on data stored in the memory after any analysis points were selected. The user does NOT need to operate the breaker again to acquire new contact velocity data after changing the analysis points because a new velocity is calculated from the travel data stored in memory from the last operation.
- The included VCBA S2 PC software can be used for more complex velocity calculations.

#### 3.12.1. Setting Up the OPEN Analysis Points

Follow the steps below to setup the OPEN analysis points:

- Start from the "START-UP" menu:

```
1. TIME BREAKER
2. GET RESULTS
3. SETUP
4. DIAGNOSTICS
```

Press the **[3]** key (*SETUP*).

- The following screen will be displayed:

```
1. ANALYSIS POINTS
2. MEASUREMENT UNITS
3. SAVE / RESTORE
4. SHOT DESCRIPTION
5. NEXT PAGE
```

Press the **[1]** key (*ANALYSIS POINTS*).

c. The following screen will be displayed:

```
1. OPEN TIMING
2. CLOSE TIMING
3. PRINT SETTINGS
4. TEST PLANS
```

Press the **[1]** key (*OPEN TIMING*)

**NOTE**

If you would like to see the current AP1 and AP2 settings, press the **[3]** key (*PRINT SETTINGS*). The settings will be printed on the thermal printer, and you will be returned to the "START-UP" menu.

d. The following screen will be displayed:

```
OPEN ANALYSIS PT 1
1. PERCENT OF STROKE
2. DIST FROM CLOSE
3. CONTACT #1
```

Press the **[2]** key (*DIST FROM CLOSE*)

**NOTES****Option details**

- **PERCENT OF STROKE**  
Percent of stroke is the distance based on the percentage of the total breaker's stroke distance. The distance is always measured from the starting point at the fully closed position of the breaker contacts.
- **DIST FROM CLOSE**  
The distance from Close range is selectable from 00.0 inch to 99.99 inches or from 0.0 centimeter to 99.90 centimeters. The distance is referenced from the contact's closed position.
- **CONTACT #1**  
Contact point is the distance from the contact's closed position to the point where it is in transition from the close-to-open or the open-to-close position. Contact channel #1 is used for this option.



- e. The following screen will be displayed:

```

OPEN ANALYSIS PT 1

VALUE: 1.00 IN
DIST FROM CLOSE

"ENTER" TO CONFIRM

```

Press the **[ENTER]** key to accept the value displayed or type a different value using the keypad. Press the **[ENTER]** key.

- f. The following screen will be displayed:

```

OPEN ANALYSIS PT 2

1. PERCENT OF STROKE
2. DIST FROM CLOSE
3. CONTACT +/- TIME

```

Press the **[2]** key (*DIST FROM CLOSE*).



#### NOTES

#### Option details

- **PERCENT OF STROKE**  
Percent of stroke is the distance based on the percentage of the total breaker's stroke distance. The distance is always measured from the starting point at the fully closed position of the breaker contacts.
- **DIST FROM CLOSE**  
The distance from Close range is selectable from 00.0 inch to 99.99 inches or from 0.0 centimeter to 99.90 centimeters. The distance is referenced from the contact's closed position.
- **CONTACT +/- TIME**  
For "CONTACT + TIME", the user enters time in milliseconds after the contact channel #1 made the transition from open-to-close or close-to-open to define analysis point 2.  
For "CONTACT – TIME", the user enter the time in milliseconds before the contact channel #1 makes the transition from open-to-close or close-to-open to define analysis point 2.

- g. The following screen will be displayed:

```
OPEN ANALYSIS PT 2  
  
VALUE: 1.00 IN  
DIST FROM CLOSE  
  
"ENTER" TO CONFIRM
```

Press the **[ENTER]** key to accept the value displayed or type the new value using the keypad. Press the **[ENTER]** key. The OPEN analysis points will be set and you will be returned to the "START-UP" menu.

<http://www.51082245.com>

### 3.12.2. Setting Up the CLOSE Analysis Points

Follow the steps below to setup the CLOSE analysis points:

- a. Start from the "START-UP" menu:

```
1. TIME BREAKER
2. GET RESULTS
3. SETUP
4. DIAGNOSTICS
```

Press the **[3]** key (*SETUP*).

- b. The following screen will be displayed:

```
1. ANALYSIS POINTS
2. MEASUREMENT UNITS
3. SAVE / RESTORE
4. SHOT DESCRIPTION
5. NEXT PAGE
```

Press the **[1]** key (*ANALYSIS POINTS*).

- c. The following screen will be displayed:

```
1. OPEN TIMING
2. CLOSE TIMING
3. PRINT SETTINGS
4. TEST PLANS
```

Press the **[2]** key (*CLOSE TIMING*).

- d. The following screen will be displayed:

```
CLOSE ANALYSIS PT 1

1. PERCENT OF STROKE
2. DIST FROM CLOSE
3. CONTACT #1 CLOSE
```

Press the **[2]** key (*DIST FROM CLOSE*).

- e. The following screen will be displayed:

```
CLOSE ANALYSIS PT 1  
  
VALUE: 1.00 IN  
DIST FROM CLOSE  
  
"ENTER" TO CONFIRM
```

Press the **[ENTER]** key to accept the value displayed or type a different value using the keypad. Press the **[ENTER]** key.

- f. The following screen will be displayed:

```
CLOSE ANALYSIS PT 2  
  
1. PERCENT OF STROKE  
2. DIST FROM CLOSE  
3. CONTACT +/- TIME
```

Press the **[2]** key (*DIST FROM CLOSE*).

- g. The following screen will be displayed:

```
CLOSE ANALYSIS PT 2  
  
VALUE: 1.00 IN  
DIST FROM CLOSE  
  
"ENTER" TO CONFIRM
```

Press the **[ENTER]** key to accept the value displayed or type the new value using the keypad. Press the **[ENTER]** key. The CLOSE analysis points will be set and you will be returned to the "START-UP" menu.

## 4.0 GLOSSARY OF TERMS

### Breaker Bounce-Back Distance

Bounce-back is the distance the breaker contact moves before the resting position after the over-travel. Bounce-back is typically found in the close operation.

### Breaker Over-Travel Distance

Over-travel is the distance the contact moves beyond the resting position. Over-travel is typically found in the close operation.

### Breaker Stroke

Circuit breaker contact stroke is the absolute distance measured from the open position to the close position, excluding the over-travel and bounce-back distance. The DigiTMR uses a digital transducer to measure a breaker's contact stroke, over-travel and bounce-back. The digital transducer outputs 200 counts per linear inch of travel, therefore the resolution is accurate to about 1/200 inch. The output resolution is  $\pm 0.01$  inch on the test result report.

Unlike resistor-type transducers, the DigiTMR's transducer needs no calibration or setup. A user verifies the transducer's functionality by selecting a diagnostic test for the transducer.

### Breaker Velocity (Speed)

The DigiTMR, when used with a travel transducer, calculates the breaker contact velocity through the arc zone. Users need to program the calculation points or analysis points on the travel curve for the unit to calculate the contact velocity. Velocity calculation points are shown as Point 1 and Point 2 under the "Speed Analysis" section of the tabulated report.

### Contact Wipe

Contact wipe is the distance measured from the close position to the contacts touching or parting positions. In the close operation, contact wipe is measured from the contacts touching position to the final close position. In the open operation, the contact wipe is measured from the close position to the contact break or parting position.

**NOTE**

Contact wipe is measured during an operation. The measurement may not be as accurate as the measurement done using the Slow-Close Mode. It is recommended that the Slow-Close Test be used to verify the contact wipe measurement.

## 5.0 DIGITMR S2 TROUBLE-SHOOTING GUIDE

PROBLEM DESCRIPTION	Possible Causes and Suggested Solutions
<b>The DigiTMR S2 will neither trip nor close the breaker.</b>	<ul style="list-style-type: none"> <li>• Make sure you hold the “ARM” switch down during each test.</li> <li>• Check the OPEN or CLOSE fuses.</li> <li>• Check the initiate leads. For a “Positive Trip” circuit, one Close lead and one Open lead should be connected to the Positive side of the power supply.</li> <li>• Check the initiate leads. For a “Negative Trip” circuit, one Close lead and one Open lead should be connected to the Negative side of the power supply.</li> </ul>
<b>Message displayed on LCD: “TRIGGER FAULT” No Trigger Using external trigger</b>	<ul style="list-style-type: none"> <li>• Trigger voltage was not detected by the DigiTMR S2</li> <li>• Check the external trigger input to the DigiTMR S2</li> <li>• Make sure the external trigger signal is present when the DigiTMR S2 displays “AWAITING TRIGGER”</li> </ul>
<b>No contact time (0 ms) in Trip or Close test.</b>	<ul style="list-style-type: none"> <li>• Make sure one side of the breaker is not grounded.</li> <li>• Make sure the breaker operates on the Open or Close test only. A dual operation Open-Close or Close-Open will result in a 0ms reading.</li> <li>• The DigiTMR S2 contact channels may be damaged or you may have bad cables. Try the “CHECK HOOK-UP” test. Please see section 3.8.3 for details.</li> </ul>
<b>No contact time (0 ms) in Close-Open test.</b>	<ul style="list-style-type: none"> <li>• Make sure the breaker contacts complete the transition from the Open (initial state) to the Close, then to the Open (final state). You can see the transition by looking at the timing chart.</li> <li>• Make sure the contact Close state is longer than 10 ms. The DigiTMR S2 has a 10ms de-bounce time. Any contact state less than or equal to 10 ms is invalid, thus the delay time is probably too slow.</li> <li>• Try the Close-Open using the contact channel #1 option</li> </ul>
<b>When selecting an Open-Close test, the breaker opens but will not close.</b>	<ul style="list-style-type: none"> <li>• Delay between Open to Close is probably too small. Increase delay time.</li> </ul>
<b>No data or erratic reading on travel transducer.</b>	<ul style="list-style-type: none"> <li>• You may have a defective transducer. Try the “TEST TRANSDUCER” diagnostics test. Please see section 3.8.2 for details.</li> <li>• Transducer slider is not secured to timing rod.</li> <li>• Transducer is not secured properly.</li> </ul>
<b>No activity on “V2” voltage input channel.</b>	<ul style="list-style-type: none"> <li>• The “V2” voltage input channel requires a voltage change from 0V to above 30V in order to show activity on the timing chart.</li> </ul>

**No "PASS" or "FAIL" indicators on the tabulated report.**

- Test plan was not loaded before performing a test. Load a test plan and then re-print the tabulated report.

**How does one review the current analysis setting?**

- From the "START-UP" menu, press the **[3]** key (*SETUP*).
- Press the **[1]** key (*ANALYSIS POINTS*).
- Press the **[3]** key (*PRINT SETTINGS*). The current AP1 & AP2 settings will be printed.

<http://www.51082245.com>

# APPENDIX

## Appendix A. ITE Circuit Breaker Model 14.4K Timing Chart

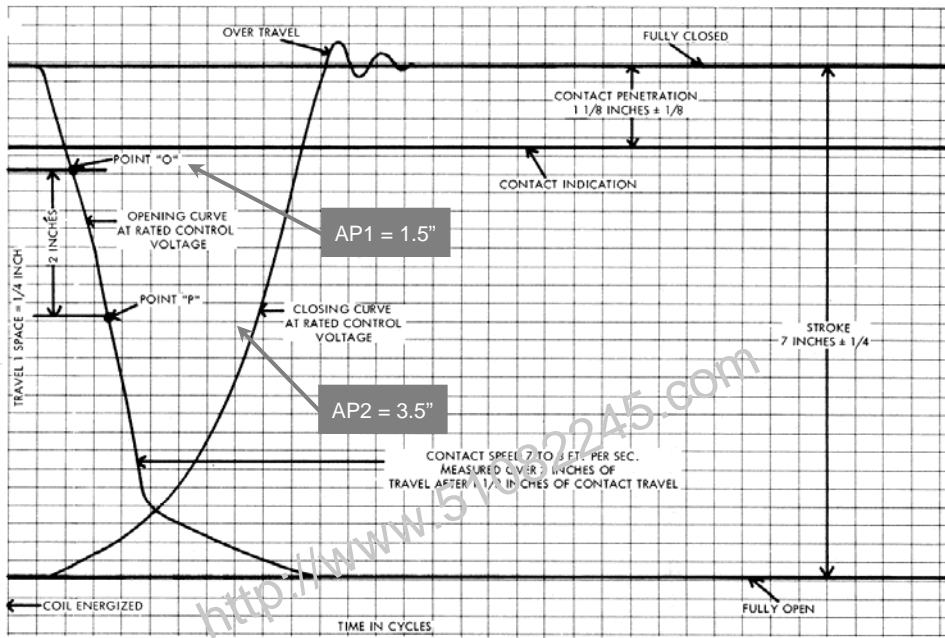

TYPICAL NO LOAD TRAVEL CURVES FOR OPENING AND CLOSING OPERATIONS AT RATED CONTROL VOLTAGE

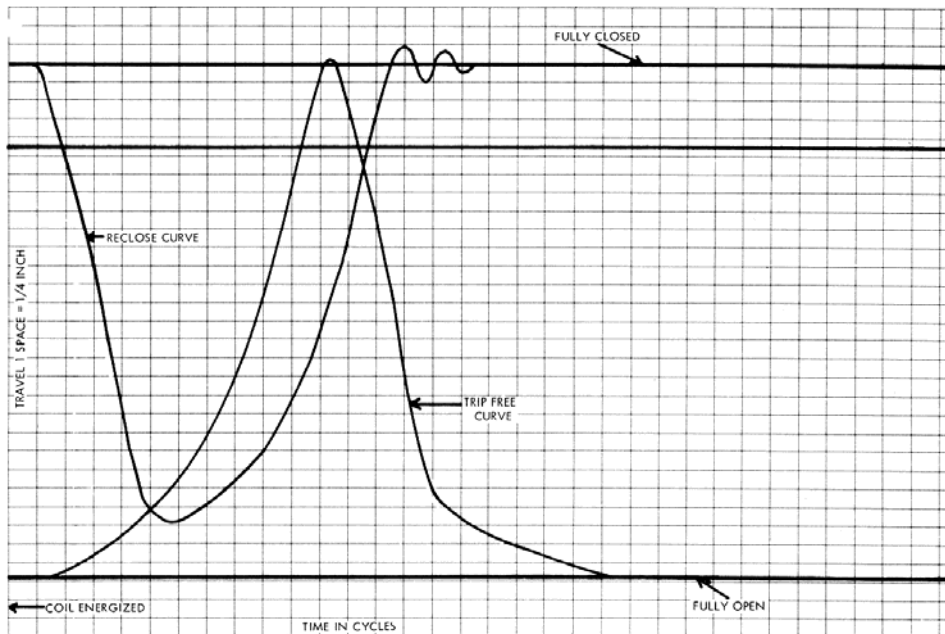

TYPICAL NO LOAD TRAVEL CURVES FOR RECLOSING AND TRIP-FREE OPERATIONS AT RATED CONTROL VOLTAGE



Appendix B. DigiTMR S2 Test Plan for ITE Circuit Breaker Model 14.4K

TEST PLAN NUMBER 1				
MFR:	14.4KS500-20B			
TYPE:	ITE			
COMMENT:				
CONTACT TIME PARAMETERS				
		OPEN	CLOSE	
MAX <ms>		035.0	180.0	
MIN <ms>		030.0	170.0	
DELTA LIM <ms>		006.0	008.0	
RESISTOR TIME PARAMETERS				
		OPEN	CLOSE	
MAX <ms>		999.0	999.0	
MIN <ms>		000.0	000.0	
DELTA LIM <ms>		010.0	010.0	
TRAVEL PARAMETERS				
	STRK	VEL	E-TUJ	BNC-BK
	in	ft/s	in	in
OPEN HI	07.25	43.54	00.20	00.20
OPEN LOW	06.75	00.00	00.00	00.00
CLOSE HI	07.25	07.00	00.40	00.25
CLOSE LO	06.75	04.50	00.00	00.00
OPEN SPEED ANALYSIS POINTS:				
	POINT 1 = 01.50 in			
	POINT 2 = 03.50 in			
CLOSE SPEED ANALYSIS POINTS:				
	POINT 1 = 01.50 in			
	POINT 2 = 03.50 in			

Appendix C. DigiTMR S2 Timing Chart for ITE Circuit Breaker Model 14.4K

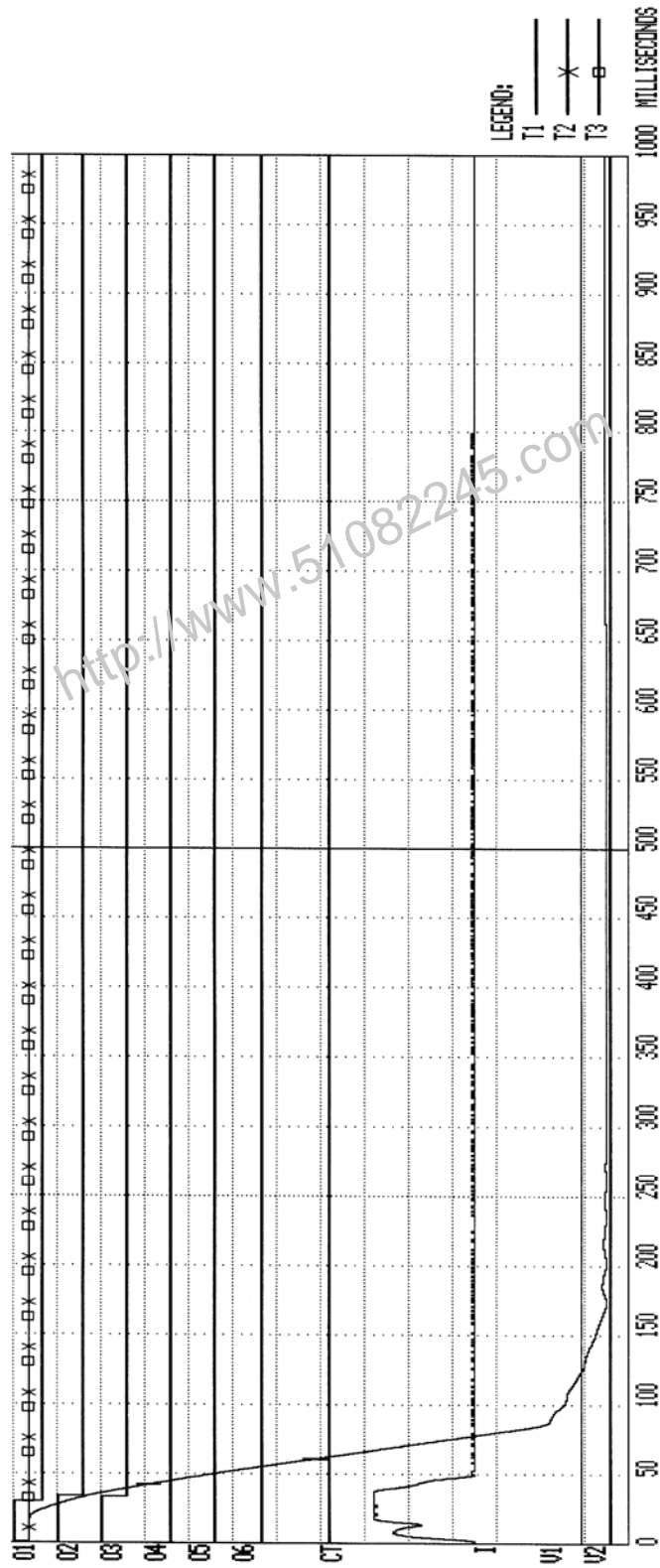

Appendix D. DigiTMR S2 Timing Chart for ITE Circuit Breaker Model 14.4K

BREAKER TIMING RESULTS - 60 Hz						
SHOT NUMBER: 0007						
DATE: 12/22/00 TIME: 10:35:03						
COMPANY: VANGUARD INSTRUMENT						
STATION: ONTARIO						
CIRCUIT:						
MFR: ITE						
MODEL: 14.4KS500-20B						
S/N: 12345						
OPERATOR: HAI						
TEST: OPEN						
CONTACT TIME						
CH	TIME	CYCLE	P/F	BOUNCE	WIPE	
	<ms>			<ms>	<in>	
1	029.50	01.77	FAIL	000.20	00.49	
2	033.10	01.99	PASS	000.20	00.72	
3	033.00	01.98	PASS	000.30	00.71	
4	000.00	00.00	FAIL	000.00	00.00	
5	000.00	00.00	FAIL	000.00	00.00	
6	000.00	00.00	FAIL	000.00	00.00	
DELTA TIME <ms> 003.60 PASS						
TRAVEL ANALYSIS T1 P/F						
STROKE in 07.00 PASS						
SPEED ft/s 09.11 PASS						
OVER-TRAVEL in 00.02 PASS						
BOUNCE BACK in 00.00 PASS						
TRAVEL ANALYSIS T2 P/F						
STROKE in 00.00 FAIL						
SPEED ft/s 00.00 PASS						
OVER-TRAVEL in 00.00 PASS						
BOUNCE BACK in 00.00 PASS						
TRAVEL ANALYSIS T3 P/F						
STROKE in 00.00 FAIL						
SPEED ft/s 00.00 PASS						
OVER-TRAVEL in 00.00 PASS						
BOUNCE BACK in 00.00 PASS						
SPEED ANALYSIS:						
POINT 1 = 01.50 in						
POINT 2 = 03.50 in						
U1 NOMINAL VOLTAGE = 0 VOLTS						
U1 MINIMUM VOLTAGE = 0 VOLTS						
INITIATOR CURRENT = 05.2 AMPS						
SHOT LENGTH: 1 SECOND						
INSERTION RESISTOR: NO						
TRIGGER: INTERNAL						

VANGUARD INSTRUMENT CO., HPN (C) 1998,99,2000  
 1710 GREVILLEA CT., ONTARIO, CA 91761, USA  
 TEL (909)923-9990 FAX (909)923-9391  
 REV: 1.312  
 OPERATION: 0009  
 SERIAL NUMBER: 75035  
 CLOSE THRESHOLD = 020 OPEN THRESHOLD = 200 CT THRES = 255  
 SAMPLE = 011 VOLTAGE = 064

Appendix E. Timing Chart and Plan for Siemens Type SPS2, 121 Circuit Breaker

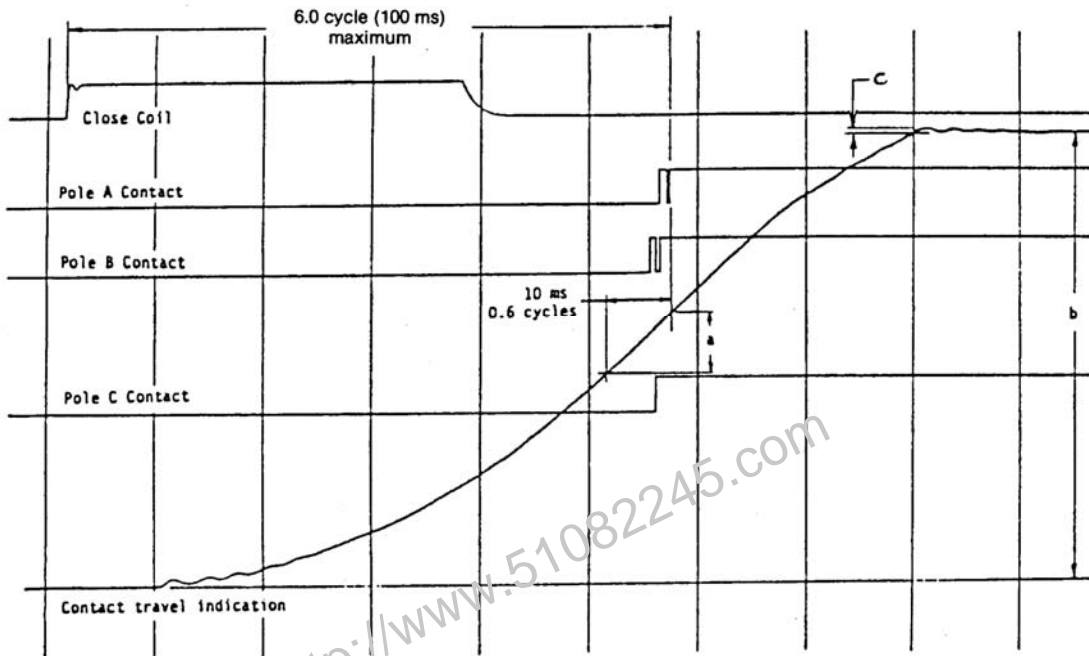

Sample Travel Analyzer Record For a Closing Operation

This particular breaker requires the following formula for calculating the Contact Closing Velocity. This formula is programmed into the breaker test plan.

$$V = 31.5 \frac{a}{b} \text{ meter/second}$$

TEST PLAN NUMBER 2			
MFR:	TCP-121		
TYPE:	SIEMENS		
COMMENT:			
CONTACT TIME PARAMETERS			
	OPEN	CLOSE	
MAX <ms>	032.0	100.0	
MIN <ms>	029.0	090.0	
DELTA LIM <ms>	005.0	005.0	
RESISTOR TIME PARAMETERS			
	OPEN	CLOSE	
MAX <ms>	999.0	999.0	
MIN <ms>	000.0	000.0	
DELTA LIM <ms>	010.0	010.0	
TRAVEL PARAMETERS			
	STRK in	VEL ft/S	D-TVL BNC-BK in in
OPEN HI	02.17	27.88	00.12 00.12
OPEN LDW	01.97	21.32	00.00 00.00
CLOSE HI	02.17	16.40	00.20 00.20
CLOSE LD	01.97	12.46	00.00 00.00
VEL = Cx(DIST<AP1 - AP2>/STROKE)			
C = 31.50 M/S			
OPEN SPEED ANALYSIS POINTS:			
POINT 1 = CONTACT			
POINT 2 = CONTACT PLUS 010.0 ms			
CLOSE SPEED ANALYSIS POINTS:			
POINT 1 = CONTACT			
POINT 2 = CONTACT MINUS 010.0 ms			

Specific Test Plan for the Siemens Type SPS2, 121 Circuit Breaker

Appendix F. DigiTMR S2 Compatible Transducers and Transducer Adapters

	<p><b>ABB AHMA-8 Mechanism Transducer</b></p>		<p><b>ABB AHMB-8 Mechanism Transducer</b></p>
	<p><b>Linear Transducers</b> Available in 10", 25", and 30"</p>		<p><b>Rotary Transducer</b></p>
	<p><b>15" Universal Transducer</b></p>		<p><b>Rotary Transducer with Magnetic Mount</b></p>
	<p><b>Resistor-Type Transducer</b></p>		<p><b>Westinghouse SF/SFA Transducer</b></p>
	<p><b>Resistor Transducer Adapter</b></p>		<p><b>Doble Transducer Adapter</b></p>



Figure 26. Linear Transducer on an OCB



Figure 27. Rotary Transducer on Alstom HE 1014 Circuit Breaker



Figure 28. Rotary Transducer on ABB HMB Mech



Figure 29. Westinghouse SFA Transducer Installation

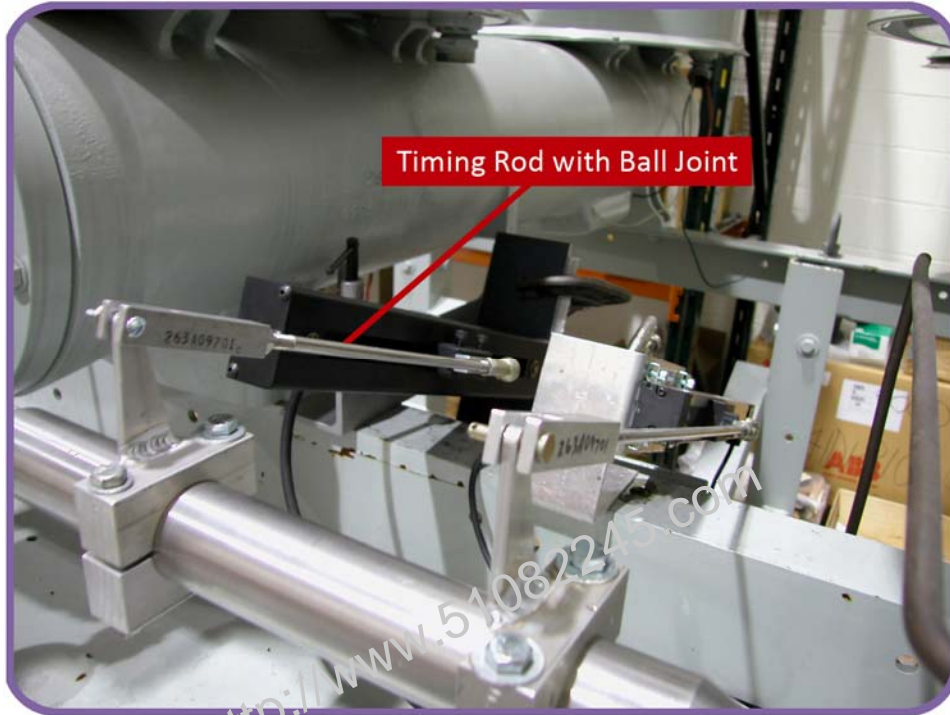

Figure 30. ABB 72PM Circuit Breaker with Linear Transducer and Special Timing Rod

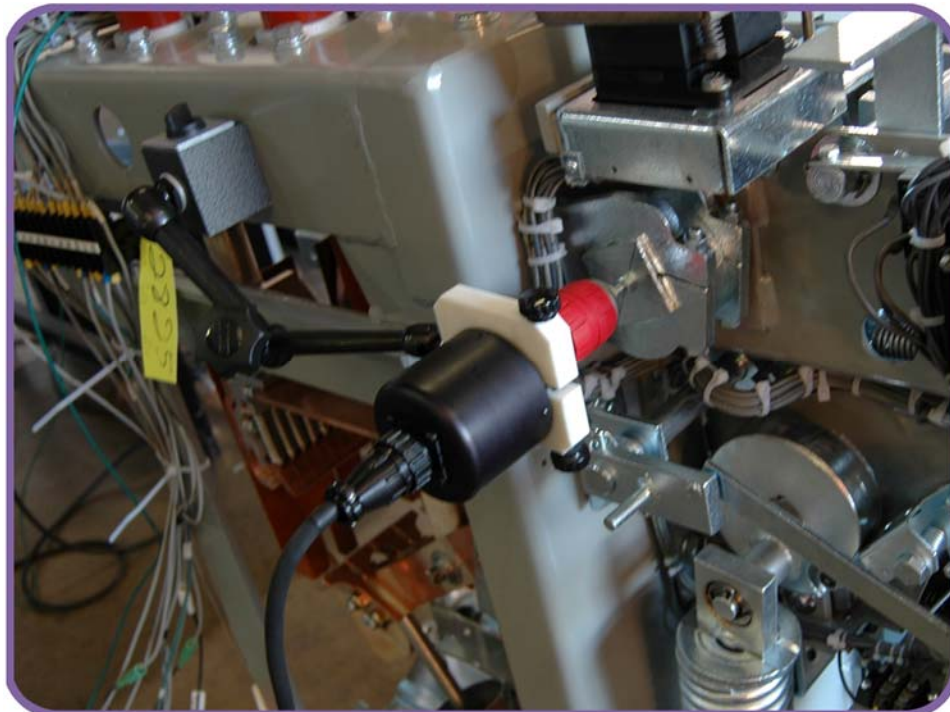

Figure 31. Rotary Transducer on Megna Blast Breaker





Figure 32. Rotary Transducer on Federal Pacific Breaker



Figure 33. Linear Transducer on Mitsubishi 500-SFMT



Figure 34. Linear Transducer on Areva DT1-72.5F



**Vanguard Instruments  
Company, Inc.**

**1520 S. Hellman Ave • Ontario, CA 91761 • USA**

**Phone: 909-923-9390 • Fax: 909-923-9391**

**[www.vanguard-instruments.com](http://www.vanguard-instruments.com)**

**Copyright © 2012 by Vanguard Instruments Company, Inc.**

**DigiTMR S2 User's Manual • Revision 1.0 • July, 2012 • TA**